



# Operating and maintenance manual

## VB 35 - VB 60 - VB 80 - VB90 - VB 120 - VB 160

Translation of the original instructions



*Thank you for choosing this machine. Please read this manual which will allow you to use the machine in a way that is safe for you and for others. While reading the manual, take the time to familiarise yourself with the new machine and you will be able to appreciate all of its advantages. You will see that it is user-friendly and how it can easily change your working process, optimising it and making it more profitable. You will understand how the technology used will be of great help to your business TELME S.p.A. machines are the product of years of experience manufacturing machines for processing foodstuffs. The quality of our machines makes them competitive, reliable, user-friendly, low maintenance, quiet, safe and ergonomic.*

*To keep your machine in proper working order, you must carry out the routine maintenance indicated in the manual. Daily cleaning is fundamental and ensures that machines remain reliable.*

*To allow us to make sure that the manuals we issue are complete and cover all possible subjects, please send us any comments based on your direct experience of using the machine.*

*For operator safety and machine integrity, the machine must only be used for the purpose for which it was built. Therefore, any modifications to the machine, any part of its design, safety device or system is strictly forbidden. Such changes will void any guarantees. The manufacturer declines all responsibility in the event of substitution of components with non-original parts, improper use, tampering, lack of maintenance, removal of safety devices and, more generally, any change made to the original design. Our qualified technical assistance service is always available to you if you have any questions.*

*Please contact your dealer to solve any technical issues. Do not attempt to solve them yourself, since this may result in serious danger.*

*All of the staff at STOELTING and its dealers hope that you will enjoy working with our machines!*

*This operating and maintenance manual is part of the machine and must always be kept with it, even if the machine is sold to a new buyer.*

## CONTENTS

<b>1 GENERAL INFORMATION</b>	<b>6</b>
1.1 General safety instructions	6
1.2 Information about precautions, specific warnings and symbols	6
1.3 Purpose of the manual	7
• 1.3.1 Structure of the manual	7
• 1.3.2 Modifications and additions	7
• 1.3.3 Requesting help – Technical assistance service	7
1.4 Machine identification data	8
1.5 Intended uses	8
• 1.5.1 Reasonably foreseeable improper use	9
1.6 Information for personnel authorised to use the machine	9
1.7 Packaging, transportation and storage	10
• 1.7.1 Transportation, lifting and handling	10
• 1.7.2 Machine storage	10
<b>2 TECHNICAL SPECIFICATIONS</b>	<b>11</b>
2.1 General description of the machine	11
2.2 Illustration of the machine as a whole and its components	12
2.3 Working and control position	14
2.4 Machine technical data	14
2.5 Noise	16
2.6 Items supplied with the machine	16
<b>3 GENERAL SAFETY REGULATIONS</b>	<b>16</b>
3.1 General instructions	16
3.2 Safety devices present on the machine	18
• 3.2.1 Safety device installed on the cover	18
• 3.2.2 Safety device of the extraction door	18
• 3.2.3 Safety symbols and stickers	19
3.3 Personal Protective Equipment (PPE)	19
• 3.3.1 Clothing	19
• 3.3.2 Gloves (hand protection)	19
• 3.3.3 Hair cover	19
<b>4 INSTALLATION INSTRUCTIONS</b>	<b>20</b>
4.1 General requirements	20
4.2 Ambient conditions	20
4.3 Spaces needed for use of the machine	21
4.4 Installation and assembly sequences of machine components	21
4.5 Electricity supply	22
4.6 Water-cooled machine	23
4.7 Air-cooled machine	24

<b>5 MACHINE OPERATION</b>	<b>25</b>
5.1 Controls	25
5.2 Switching on and starting the machine	27
5.3 Programming (All models)	28
• 5.3.1 Adjusting the temperature-based cooling cycle (P1)	29
• 5.3.2 Adjusting the time-based cooling cycle (P2)	29
• 5.3.3 The machine operating time (P3) (only models VB 35, VB 60, VB 80)	30
• 5.3.4 Adjusting the buzzer (P3) (only models VB90, VB120, VB160)	31
• 5.3.5 Gelato retain time (P4) (only models VB90, VB120, VB160) (only with Time-based cycle production)	31
• 5.3.6 The machine operating time (P5) (only models VB 90, VB120, VB160)	31
• 5.3.7 Cylinder Temperature Retain Function (button F) (only models VB90, VB120, VB160)	32
5.4 Temperature-based cycle production	33
• 5.4.1 Modifying the cooling temperature with the temperature-based cycle started	34
5.5 Time-based cycle production	35
• 5.5.1 Modifying the mixing time with the time-based cycle started	36
<b>6 PRE-WASHING</b>	<b>37</b>
<b>7 WASHING</b>	<b>37</b>
7.1 Simple washing	38
• 7.2 Accurate washing and disassembling of the parts	39
• 7.3 Reassembly	42
• 7.4 Sanitization	44
<b>8 ROUTINE MAINTENANCE</b>	<b>46</b>
8.1 Type of checks and interval between them	46
8.2 Maintenance work	46
8.3 Maintenance intervals and time needed	46
8.4 Maintenance sheets	47
8.5 Checks on safety devices	50
• 8.5.1 Checking the safety device installed on the cover	50
<b>9 TROUBLESHOOTING</b>	<b>51</b>
9.1 General alarm indications displayed on the control panel – causes and solutions	52
9.2 Troubleshooting – flowchart	56
<b>10 INACTIVITY</b>	<b>61</b>
10.1 Keeping the machine efficient if it remains inactive	61
<b>11 DECOMMISSIONING THE MACHINE</b>	<b>62</b>
11.1 Description of method of disposal	62

---

# 1 GENERAL INFORMATION

## 1.1 General safety instructions

Before using the machine, carefully read all of this manual, which is an integral part of the machine.

Knowing the information and instructions in this manual is essential for users to use the machine correctly and safely.

The manufacturer declines all responsibility in the event of modifications, tampering or any operations carried out in a way that does not coincide with what is specified in this manual, since they may put the health and safety of personnel and/or objects at risk. The manufacturer reserves the right to take legal action against anyone who modifies its machines without written permission.

The person in charge of machine use and/or the employer must make sure that users are trained and aware of all information and instructions in the documentation supplied.

Users are only permitted to carry out work on the machine which is within their area of responsibility and for which they have been trained.

The user shall be held fully responsible for any modifications he makes to the machine.

Only operators with the appropriate professional technical qualifications may carry out checks or repairs on the machine. Reliable operation and optimised machine performance are only guaranteed by the use of original spare parts. The manufacturer reserves the right to make any changes considered appropriate to the machine described without prior notice.

The user is responsible for all operations needed to keep the machine efficient during its use.

## 1.2 Information about precautions, specific warnings and symbols

Where necessary, this manual includes information alongside machine operating and maintenance instructions or procedures.



There are also indications marked with the “Caution/Danger” symbols, shown in bold type and upper case letters to make them clearly visible.

The “GENERIC CAUTION/DANGER” symbol is used to indicate that failure to comply with the safety regulations described in this manual could result in **“Damage to the machine and/or objects and injury to machine users”**.





## **1.3 Purpose of the manual**

This manual was drawn up with the aim of providing all machine users, in the most complete and clearest way possible, with all information necessary for machine installation, use and maintenance, from the time the machine reaches the market until the day it is decommissioned and/or scrapped.

It also lists all procedures useful for dealing with emergencies which may arise during use of the machine as described by the manufacturer and those which are reasonably foreseeable.

**IMPORTANT NOTE: THE MANUAL DOES NOT SUBSTITUTE TECHNICAL TRAINING FOR PERSONNEL WHO WILL USE THE MACHINE. IT SHOULD BE CONSIDERED A GUIDE TO THE USE OF MACHINE FUNCTIONS.**

### **1.3.1 Structure of the manual**

The manual consists of a single document drawn up in descriptive language and with all figures necessary for correct interpretation and implementation of the activities required for machine operation and maintenance.

This manual includes all instructions with which the user must be familiar and information which the user may consult in order to achieve the aims of the manual.

### **1.3.2 Modifications and additions**

This manual reflects the state of the machine at the time it reached the market and is considered an integral part of the machine.

Any modifications, improvements or adjustments applied to machines subsequently marketed do not oblige the Factory to apply such changes to a machine previously supplied, nor to consider it and the related manual lacking and inadequate.

the Factory reserves the right, should it deem it appropriate and for valid reasons, to update the manuals already on the market, sending its customers sheets of technical and/or operating updates which must be considered and kept in the manual.

### **1.3.3 Requesting help – Technical assistance service**

Any request for action by the Technical Assistance Service must be sent by fax or e-mail to the dealer from which the machine was purchased. The manufacturer's sales/support network can be found at <http://www.stoelting.com>

When requesting help or technical assistance, always specify:

1. type of machine, model, product code, serial number and year of construction;
2. faults found;
3. dealer through which the machine was purchased;
4. tax document indicating the date of machine purchase by the user.



## 1.4 Machine identification data

The data plate is located at the top of the machine rear panel and shows all of the data needed for machine identification.

	MODEL	1				
	S/N	2	YEAR/MONTH	3		
	V	4	Hz	5	Ph	6
	COOLING AIR	Kw	7	A	8	
	GAS	9	gr./oz			
	LOW-SIDE (PSIG)	10	HIGH-SIDE(PSIG)			

- |                                     |  |
|-------------------------------------|--|
| 1. Model – type of machine;         | 6. Number of phases;                     |
| 2. Machine serial number;           | 7. Max. power;                           |
| 3. Date of production (Year);       | 8. Max. current drawn;                   |
| 4. Electric power supply voltage;   | 9. Type and quantity of refrigerant gas; |
| 5. Electric power supply frequency; | 10. The values of high and low pressure. |

This data must be indicated in all information documents, for example for every request for technical assistance or when requesting spare parts.



**REMOVAL OF OR TAMPERING WITH THE IDENTIFICATION PLATE IS STRICTLY PROHIBITED.**

## 1.5 Intended uses

The VB range of machines are designed for:

1. mixing, churning the pasteurized mix or ready-packaged foods, inserted in the machine cylinder, for making gelato, sorbet and granita.
2. chilling and freezing the ingredients processed, to obtain a creamy gelato, a sorbet or a granita.

This processing takes place in a vertical cylinder using a mixer and retaining paddle supplied with the machine.

The machine operating modes, for making gelato and sorbet, include “temperature-based” or “time-based” operating cycles. Plus, using a specific program, with a temperature-based cycle, it is possible to make granita.



**THE MACHINE CANNOT BE USED FOR OTHER PURPOSES WITHOUT TELME S.P.A.'S AUTHORIZATION. TELME S.P.A. WILL NOT BE RESPONSIBLE FOR DIRECT OR INDIRECT DAMAGES DUE TO IMPROPER USE OF THE MACHINE.**





### **1.5.1 Reasonably foreseeable improper use**

Based on experience using the machine in actual operating conditions, we recommend that you follow these instructions:

1. Do not insert in the cylinder a quantity of mix that is less than that recommended, as it could lead to ice forming on the cylinder wall. That would make the machine noisy, cause wear and damage to the mixer scrapers. The suitable quantity of product which can be processed is indicated in sec. 2.4 "Machine technical data" of this manual.
2. Do not insert in the cylinder a quantity of mix that is more than that recommended, as it could prevent correct mix mixing, and the product can leak out of the cylinder. That would stress the mixer's motor-driven shaft. The suitable quantity of product which can be processed is indicated in sec. 2.4 "Machine technical data" of this manual.
3. Do not press the extraction button when the mix or product in the cylinder is liquid, because the high rotating speed of the mixer (counterclockwise) would make the product come out of the cylinder suddenly. (Consult section 5.1 "Controls" in this manual).
4. Do not press the extraction button at the end of the granita production cycle, because the high rotating speed of the mixer (counterclockwise) would make the product come out of the cylinder suddenly. Press the MIX button (mixer clockwise rotation) to make the granita come out of the machine cylinder correctly and safely. (Consult section 5.1 "Controls" in this manual).
5. At the end of processing do not lift the cover and do not remove the mixer fitted in the cylinder while the temperature of the remaining product and/or of the surface of the cylinder is such that it risks causing injuries due to contact with or proximity to parts of the machine or materials at a very low temperature. Use suitable gloves that protect against low temperatures and/or use suitable protective clothing.

## **1.6 Information for personnel authorised to use the machine**

This manual contains the information needed by authorised personnel to correctly use the machine.

A knowledge of and compliance with the general safety instructions and danger warnings contained in this manual are the conditions for proceeding, in minimal risk conditions, with installation, putting into service, operating and maintenance of the machine.

Personnel authorised to use the machine:

**OPERATOR:** a person trained for routine operation of the machine, that is to say, loading products to be processed, running recipes, cleaning and routine maintenance.

**QUALIFIED TECHNICIAN:** a person whose training and professional education gives him a knowledge of machine service conditions, and who is able to work on the machine and recognise and avoid any dangerous conditions.

## 1.7 Packaging, transportation and storage

The machine is packaged in a wooden or cardboard crate on a pallet having dimensions and features suitable for the type and weight of the machine. The machine will be delivered packaged, ensuring that it is protected from the elements.

Each package is marked with the following information:

- **Type of machine, model and serial number**
- **Net and gross weight**
- **Machine destination**

Labels are applied on the package to indicate the following:

- **Handle with care**
- **This way up**
- **Protect from rain**
- **Do not stack**
- **Protect from heat sources**
- **Fragile**



### 1.7.1 Transportation, lifting and handling



**THE PACKAGE MUST ONLY BE HANDLED BY QUALIFIED TECHNICAL PERSONNEL.**

When the machine is delivered, check that during transportation in addition to visible damage no other damage was caused which could compromise correct operation. On the delivery note, write "Subject to approval" to show that acceptance of the machine is subject to checks. If any damage is found, within 48 of receiving the machine, report the damage to the haulier and the manufacturer.

Use a pallet truck or a fork-lift truck, inserting the forks in the holes in the pallet. Use equipment with suitable load-bearing capacity.



**MOVE THE MACHINE USING LIFTING EQUIPMENT WITH A SUITABLE LOAD-BEARING CAPACITY. DO NOT ATTEMPT TO LIFT THE MACHINE BY HAND.**

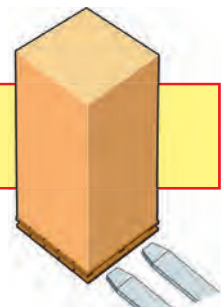

### 1.7.2 Machine storage

The package must not be subjected to impacts, vibrations and other loads.

The machine must be stored indoors, in an area free of aggressive agents, at a temperature not lower than +2 °C, not higher than +55 °C and with a humidity level of between 10% and 95% (without condensation).



---

## 2 TECHNICAL SPECIFICATIONS

### 2.1 General description of the machine

The **VB** range of machines covered by this manual are vertical batch freezers for making gelato, sorbet and granita. Processing of the mixes or ready-packaged foods is performed in a single vertical cylinder which is: "easy to fill, the product is always visible and the ingredients can be added at any time".

The **VB** range includes the following models:

- VB 35-109 a
- VB 35-309 a
- VB 60-109 a
- VB 60-309 a
- VB 80-109 a
- VB 90-109 a
- VB 120-109 a
- VB 160-109 a

"VB" models can mix, churn, chill and freeze the ingredients processed, to obtain a creamy gelato, a sorbet or a granita. The machine operating modes, for making gelato and sorbet, include "temperature-based" or "time-based" operating cycles. Plus, using a specific program, with a temperature-based cycle, it is possible to make granita.

## ***2.2 Illustration of the machine as a whole and its components***

- 1 Cover
- 2 Control panel
- 3 Cylinder
- 4 Retaining paddle
- 5 Mixer
- 6 Thermal overload protector reset
- 7 Extraction door lever
- 8 Extraction door
- 9 Extraction door chute
- 10 Basin support
- 11 Mat
- 12 Front wheels with brake
- 13 Outer panels
- 14 Rear wheels
- 15 Air cooled condenser (air version machines)
- 16 Connector for inflow of condensation water (water version machines)
- 17 Connector for outflow of condensation water (water version machines)

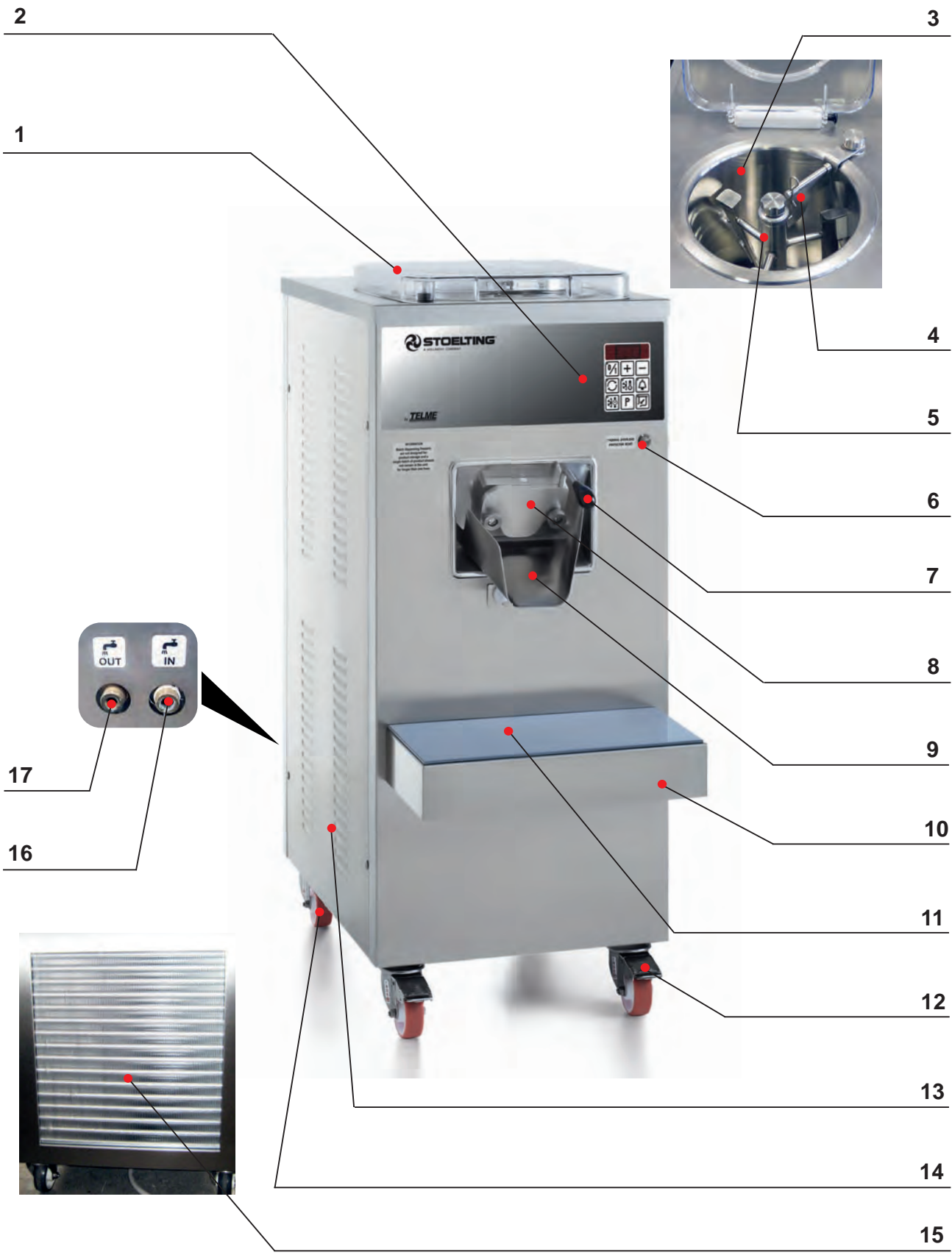

## 2.3 Working and control position

The operator must stand in front of the machine and load the ingredients, programme the recipe, start the processing and unload the processed product at the end of the recipe.

## 2.4 Machine technical data

Model		VB 35	VB 60	VB 80
Net weight	kg	170	200	250
Coolant gas (type)		R448A		
For water version (quantity)	g	1300	1700	1800
For air version (quantity)	g	1650	3000	/
Quantity of product that can be processed (min. - max.)	L	3 to 7	4 to 8	7 to 11
Max ambient temperature	°C (°F)	+30 (+86)		
Cylinder capacity	L	14	23	28
WATER version machine:(coolant gas pressure)	bar	14	14	14
"CONDENSATION" (coolant gas temperature)	°C	+32 (+89,6)		
WATER version machine:(coolant gas pressure)	bar	1.0 to 0.6		
"EVAPORATION" (coolant gas temperature)	°C (°F)	-30 to -36 (-22 to -32,8)		
Mains water temperature	°C (°F)	+18 to +20 (+64,4 to +68)		
Infeed water pressure	bar	1 to 7		
Water consumption	L /min.	3 to 4	4 to 5	4 to 5
AIR version machine: (coolant gas pressure)	bar	17.2 to 22		
"CONDENSATION" (coolant gas temperature)	°C (°F)	+40 to +50 (+104 to +122)		
AIR version machine: (coolant gas pressure)	bar	1.0 to 0.6		
"EVAPORATION" (coolant gas temperature)	°C (°F)	-30 to -36 (-22 to -32,8)		

Model		VB90	VB120	VB160
Net weight	kg	290	362	382
Coolant gas (type)		R448A		
For water version (quantity system 1)	g	1400	1600	1800
(quantity system 2)	g	1400	1600	1800
Quantity of product processable (min. to max.)	L	6 to 12	5 to 18	8 to 24
Max. ambient temperature	°C (°F)	+30 (+86)		
Cylinder capacity	L	30	45	53
WATER version machine:(coolant gas pressure)	bar	14		
"CONDENSATION" (refrigerant gas temperature)	°C (°F)	+32 (+89,6)		
WATER version machine:(coolant gas pressure)	bar	1,0 to 0,6	1,0 to 0,6	1,0 ÷ 0,6
"EVAPORATION" (coolant gas temperature)	°C (°F)	-30 to -36 (-22 to -32,8)		
Mains water temperature	°C (°F)	+18 to +20 (+64,4 to +68)		
Infeed water pressure	bar	1 to 7		
Water consumption (for each system)	L /min	3 to 4	4 to 5	4 to 5

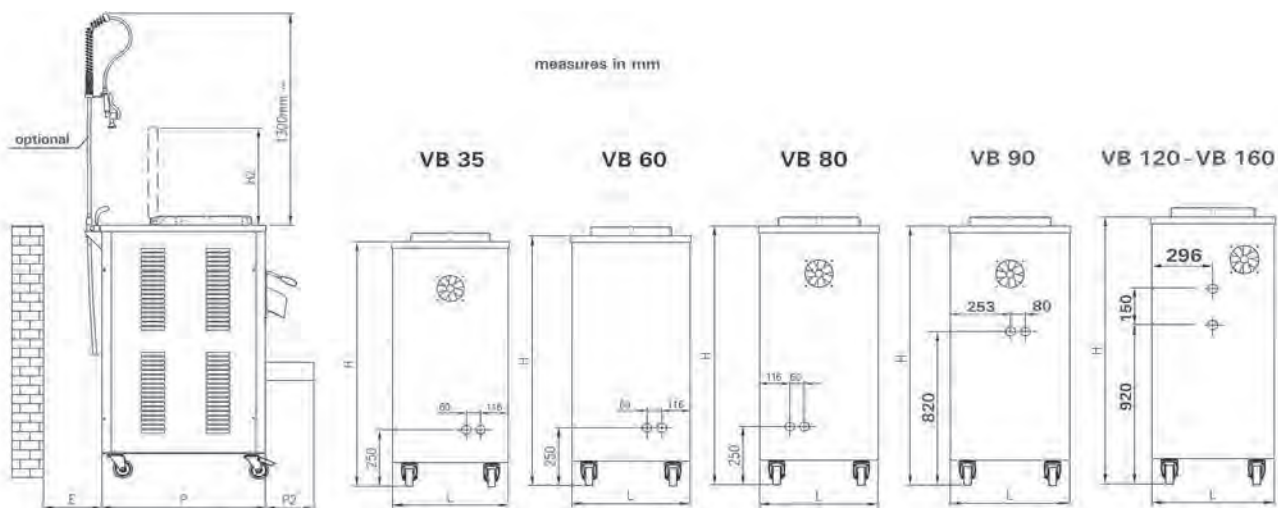

Model	VB 35	VB 60	VB 80	VB90	VB120	VB160
Dimensions L (mm)	490	490	510	510	600	600
P (mm) Water version	700	700	700	700	780	780
P (mm) Air version	700	900	/	/	/	/
H (mm)	1120	1120	1150	1150	1250	1250
H2 (mm)	390	440	440	440	500	500
P2 (mm)	200	200	220	220	220	220
For air version E (mm)	500	500	/	/	/	/
For water version E (mm)	300	300	300	300	300	300

**RATED POWER / RATED CURRENT**

Power supply voltage (Volts)	Frequency (Hz)	Phases	VB 35	VB 60	VB 80
208 / 230	60	3	3,5 kW - 17 A	7.3 kW - 26 A	8.5 kW - 34 A
208 / 230 Air version	60	3	3.7 kW - 19 A	7,6 kW - 28 A	/

**RATED POWER / RATED CURRENT**

Power supplyvoltage (Volts)	Frequency (Hz)	Phases	VB90	VB120	VB160
208/230	60	3	8.7 kW - 35 A	14 kW - 48 A	16 kW - 54 A



## 2.5 Noise

The machine is designed and built to conform to the requirements of the regulations in force.

The machine's exposure limit and action limit values, relative to the level of daily exposure to the peak noise and acoustic pressure, are respectively less than 80 dB(A) and 135 dB(C). Test documents and certificates for the instruments used for the measurements are filed at manufacturer and are available to monitoring authorities.



**TEST DOCUMENTS AND CERTIFICATES FOR THE INSTRUMENTS USED FOR THE MEASUREMENTS ARE FILED AT MANUFACTURER AND ARE AVAILABLE FOR THE MONITORING AUTHORITIES.**

## 2.6 Items supplied with the machine

The machine is supplied together with the following items:

1. Operating and maintenance manual.
2. Kit of gaskets and packet of food-safe lubricating grease
3. Spatula for gelato/ice cream
4. Tube brush for cleaning.
5. Basin for washing
6. Machine components: mixer and retaining paddle.

---

# 3 GENERAL SAFETY REGULATIONS

## 3.1 General instructions



**THE INSTRUCTIONS LISTED BELOW MUST BE CAREFULLY READ SO THAT USERS ACT APPROPRIATELY ON A DAILY BASIS WHEN OPERATING THE MACHINE AND CARRYING OUT MAINTENANCE. THIS PREVENTS ANY KIND OF ACCIDENT LINKED TO SITUATIONS INVOLVING POTENTIAL RISK FOR PEOPLE AND/OR OBJECTS.**

***For the safety of machine users, the following safety instructions must be complied with:***

1. Do not attempt to start the machine until you have acquired a suitable understanding of how it operates, by reading this manual.
2. In case of doubts, even after carefully reading this manual, contact the technical assistance service.
3. Make sure that all personnel involved in using the machine are aware of the safety instructions.
4. Before starting the machine, the operator must check for any faults and/or defects visible on the safety devices and on the machine. If any faults are found, immediately report them to the manufacturer or to the nearest authorised service centre.
5. The machine must only be used for the purposes for which it was intended and in accordance with the manufacturer's instructions.
6. Every day, check that all safety devices on the machine are operating correctly (see sections 3.2 and 8.5 of this manual).



7. Safety devices must not be removed or bypassed for any reason.
8. Any tampering with or modification of the machine not authorised in advance by the manufacturer shall release the manufacturer from any responsibility for injury/damage to people and/or objects.
9. The identification plate and safety symbols/stickers applied to the machine must be kept in perfect condition. If they are damaged, they must be promptly substituted.
10. Work on electrical connections must only be carried out by qualified technical personnel.
11. The operator must be familiar with the machine controls.
12. The operator must not carry out any operations which are not described in this manual.
13. Only purchase and use original spare parts, which are guaranteed by the manufacturer. Contact the dealer or the nearest service centre to replace faulty or damaged components.
14. Do not wear clothing, jewellery and accessories which may become tangled in machine moving parts.
15. Keep the area around the machine clear and free of obstructions.
16. Do not put fingers and/or objects in the machine slots or holes.
17. Do not use the machine with damp or wet hands.
18. Always wear suitable gloves and a hair cover for hygiene.
19. Pay maximum attention to all caution and danger signs on the machine.
20. The machine must be installed in a location protected from rain and sun.
21. Do not allow water and/or liquids to penetrate the machine.
22. Do not open the machine panels, since the machine contains components/parts which cannot be maintained by the user.
23. Do not lean or sit on the machine while it is operating.
24. Do not apply to the machine other devices which are not part of the kit supplied by the manufacturer.
25. Clean the machine outer panels with soft cloths moistened with detergent for food-safe machines. Do not use water jets, as they may damage components/parts inside the machine.
26. Do not use any kind of solvent, such as spirit, benzene or thinner to clean any of the machine surfaces.
27. Do not operate the machine while under the effects of alcohol, mental health medications or medications in general.
28. This machine must not be used by persons under the age of 18.
29. Improper use of the machine may cause hazards for operators and/or may damage the machine.
30. If the machine develops any problems not covered in this manual, contact the Technical Assistance Service.
31. Use of the machine is not permitted in places with a potentially explosive atmosphere and in places with ambient conditions not envisaged in point 4.2 of this manual.
32. The machine is not designed to be used by people with reduced physical, sensory or mental capacity.

### 3.2 Safety devices present on the machine

The term safety device refers to: “a component specially designed by the manufacturer and also sold separately from the machine in order to be able to perform safety functions. Therefore, a safety component will be considered a device whose failure to function compromises the safety of exposed persons.

#### 3.2.1 Safety device installed on the cover

The inside of the machine is fitted with a magnetic safety sensor (A, not visible in the photographs), designed to detect the magnet (B) fitted on the cover.

**! Incorrect positioning of the magnet activates a machine alarm, preventing it from starting. The magnet (B) must be positioned with the arrows (1-2) VERTICAL.**

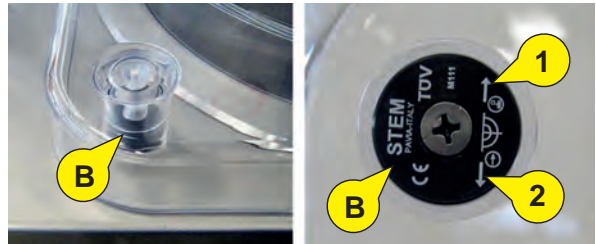

**Note:** If the cover is opened during an operating cycle (e.g.: to add ingredients), the cycle will be “PAUSED”, then will continue from where it left off only after the cover has been closed.



**THE MAGNETIC SAFETY SENSOR IN THE COVER MUST NOT BE USED AS A MACHINE STOP CONTROL.**



**THE MACHINE MUST ONLY BE STOPPED BY PRESSING THE RELATIVE "STOP" ICON, NOT BY OPENING THE COVER (SEE SECTION 5.1 "CONTROLS" IN THIS MANUAL).**

#### 3.2.2 Safety device of the extraction door

The machine has an extraction door which allows the processing cylinder to be sealed. Use the lever (A) to open the plate for extracting the processed foods.

The cylinder extraction door, used to extract the product, is fitted with a fixed grille (B) designed to prevent fingers from being inserted accidentally.

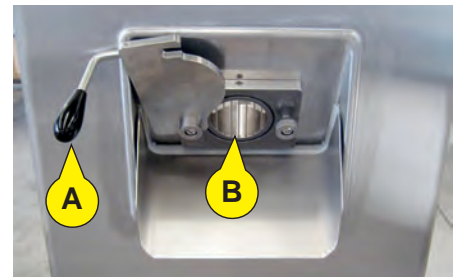

**DO NOT INSERT TOOLS (E.G.: TUBE BRUSH FOR CLEANING, ETC.) IN THE GRILLE OF THE EXTRACTION DOOR WHEN THE MACHINE IS OPERATING.**



**TAMPERING WITH THE SAFETY DEVICE AND USE OF THE MACHINE IF IT IS DAMAGED OR MALFUNCTIONING ARE STRICTLY PROHIBITED.**



**THE MANUFACTURER DECLINES ALL RESPONSIBILITY IN THE EVENT OF TAMPERING WITH SAFETY DEVICES OR OPERATIONS CARRIED OUT IN A WAY THAT DOES NOT COINCIDE WITH WHAT IS SPECIFIED IN THIS MANUAL, SINCE THEY MAY PUT THE HEALTH AND SAFETY OF PERSONNEL AND/OR OBJECTS AT RISK.**

**TAMPERING WITH THE SAFETY DEVICE AND USE OF THE MACHINE IF IT IS DAMAGED OR MALFUNCTIONING ARE STRICTLY PROHIBITED.**



### 3.2.3 Safety symbols and stickers

On the machine there are symbols/stickers for highlighting: what you must not do, important information and warnings:

This symbol indicates the presence of an electric shock hazard.

It indicates to the relevant personnel that they risk an electric shock if they do not work in compliance with safety regulations.



## 3.3 Personal Protective Equipment (PPE)

The employer must inform personnel about the following safety-related issues:

- 1 Accident risks.
- 2 Operator safety equipment.
- 3 General accident-prevention rules envisaged by the regulations in place in the country for which the machine is intended.

*The operator must always:*

- 1 Pay maximum attention to all caution or danger symbols/stickers on the machine.
- 2 Not wear clothing, jewellery or accessories which may become tangled in machine parts.

Personal protective equipment to be used by personnel authorised to use the machine:

### 3.3.1 Clothing

Operators must wear clothing made of material resistant to the type of product to be processed. The clothing must allow perfect movement for the operations that the operator must perform.



### 3.3.2 Gloves (hand protection)

Gloves must be suitable for the machine operating conditions and the operator's hands. They must guarantee a secure, rapid grip as well as high performance in resisting the product to be handled. They must guarantee adequate comfort, absorb sweat and protect against heat and cold.



### 3.3.3 Hair cover

Hair covers must be the correct size and must hold the hair inside. They must be breathable to allow for scalp sweating.



**PPE MUST CONFORM TO THE SAFETY REQUIREMENTS OF THE REGULATIONS IN FORCE IN THE COUNTRY WHERE THE MACHINE IS USED.**

## 4 INSTALLATION INSTRUCTIONS

### 4.1 General requirements



**INSTALLATION MUST ONLY BE PERFORMED BY QUALIFIED TECHNICAL PERSONNEL.**

Once the package is near to the machine installation location, cut the straps (A) and remove the cardboard (B) by pushing it upwards.

Remove the documents and accessories located on the outside of the machine.



**Take care when removing the straps, as they may accidentally hit the operator when cut.**

Remove both of the machine side panels by unscrewing the fixing screws (C) then unscrew the bolts (D) which fix the machine frame to the base of the packaging.

Lift the machine off the pallet by acting on the load-bearing parts (P) of the frame, using lifting equipment suitable for the weight of the machine. During lifting pay special attention to the power cable, taking care not to damage it.



**DO NOT ATTEMPT TO LIFT THE MACHINE BY HAND.**

After positioning the machine in the selected area, put the side panels back on using the screws and dispose of the packaging materials in accordance with the rules in force in the country where the machine will be used.

### 4.2 Ambient conditions

Ambient conditions required for machine operation:

**! Temperature: +2°C to +30°C (35.6°F to 86°F)**

**! Humidity: 10% - 95% (with no condensation)**



**THE MACHINE MUST BE POSITIONED IN A LOCATION PROTECTED FROM RAIN AND SUN.**

Ambient conditions other than those specified may cause serious damage to the machine and in particular to the electrical equipment and the refrigerating system.



**OPERATING THE MACHINE IN AMBIENT CONDITIONS THAT DO NOT CONFORM TO THE INDICATIONS IN THIS MANUAL WILL VOID THE GUARANTEE.**

**USE OF THE MACHINE IN POTENTIALLY EXPLOSIVE ATMOSPHERES IS STRICTLY PROHIBITED.**





### 4.3 Spaces needed for use of the machine

The machine must be positioned on a solid, level and even floor. It must not be directly exposed to sunlight or near to heat sources.

Keep the machine air inlets clear to allow adequate air circulation around it.

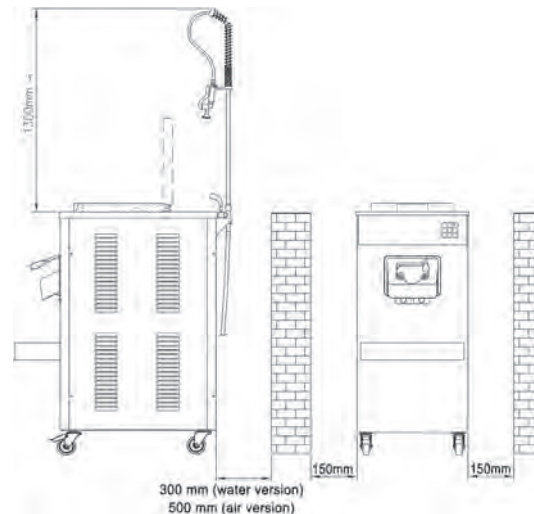

### 4.4 Installation and assembly sequences of machine components

For safety reasons and to avoid damage during transportation, some machine components are removed from it. Therefore, the machine user must follow these assembly instructions for machine components:

#### 1 Extraction door lever

- Install the opening lever (A) on the extraction door. Place it in the seat (A1) and use the Allen key (B) supplied to tighten the fixing screw while holding the lever in the operating position.

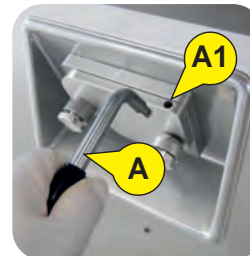

#### 2 Extraction door chute

- Install the extraction door chute below the extraction door using the fixing holes (C) on the front panel.
- Position the chute and tighten the 2 clamp screws (D) below it.



**TIGHTEN THE CLAMP SCREWS, CHECKING THAT THERE IS NO PLAY IN THE CHUTE.**

#### 3. Basin support and mat

- There are two slots (F) in the back of the basin support. Fit them over the clamp screws (G) partly tightened on the front panel. When the basin support is in place, tighten the screws.
- Place the mat (H) supplied on top of the basin support.



## 4.5 Electricity supply



**WORK ON ELECTRICAL CONNECTIONS MUST ONLY BE CARRIED OUT BY QUALIFIED TECHNICAL PERSONNEL.**

The machine must be powered at the voltage shown on the data plate at the top of the rear panel. Connect the machine only to a power supply using a suitable earth connection.

The machine is supplied with a power cable to which a **qualified technician** must connect a plug suitable for the technical data (voltage, current) on the data plate.

Connect the machine to a power socket using a suitable earth connection.



**THE ELECTRIC SYSTEM THAT WILL POWER THE MACHINE MUST BE DESIGNED IN ACCORDANCE WITH THE REGULATIONS IN FORCE AND INSTALLED BY QUALIFIED, CERTIFIED TECHNICAL PERSONNEL.**

**THE SOCKET MUST BE CONTROLLED BY A RESIDUAL CURRENT OPERATED CIRCUIT BREAKER, AND MUST HAVE AN EFFECTIVE EARTH CONNECTION.**



**THE MANUFACTURER DECLINES ALL RESPONSIBILITY FOR ANY DAMAGE CAUSED BY AN UNSUITABLE ELECTRICITY SUPPLY SYSTEM OR EARTHING.**



**AT THE END OF MACHINE INSTALLATION, QUALIFIED TECHNICAL PERSONNEL MUST CHECK THAT THE MIXER ROTATES IN THE CORRECT DIRECTION, "CLOCKWISE".**



**THE USE OF EXTENSION LEADS WHICH HAVE A CROSS-SECTION DIFFERENT TO THAT OF THE MACHINE POWER CABLE MAY RESULT IN THE FOLLOWING FAULTS:**

- 1. SLOW MOTOR START WITH TRIPPING OF OVERLOAD SWITCHES**
- 2. MOTOR OVERHEATING WITH A DROP IN POWER**
- 3. FAILURE OF MACHINE SWITCH ON - SWITCH OFF DEVICE**



**THE MANUFACTURER RECOMMENDS INSTALLATION OF THREE-PHASE MAGNETO-THERMAL OVERLOAD SWITCHES WHICH ALLOW POWER TO BE CUT OFF TO ALL PHASES EVEN IN THE EVENT OF AN OVERLOAD ON ONLY ONE OF THEM. OTHER TYPES OF MAGNETO-THERMAL SWITCHES OR FUSES ONLY CUT THE PHASE WHICH WAS SUBJECT TO OVERLOADING. IF THE VOLTAGE WERE TO FAIL IN ONE OF THE THREE PHASES, THE MACHINE WOULD NOT STOP OPERATING, BUT THE MOTORS WOULD QUICKLY SUFFER IRREPARABLE DAMAGE.**





## 4.6 Water-cooled machine

For machines with a water-cooled condenser, a water supply tube and a water drainage tube have to be fitted. Connect a valve or tap (1) before the delivery tube.



The threaded connectors are on the back of the machine, in the lower area. Each connector is marked with a label indicating its purpose, as below:

- A. IN - Machine water infeed (pressure between 1 and 7 bar)
- B. OUT - Machine water outfeed

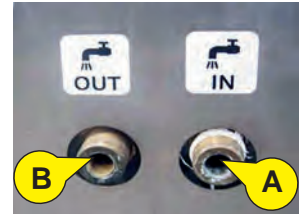

For the water connections, use rubberised fabric tubes suitable for a pressure of up to 15 bar. To connect the tubes to the machine's threaded connectors, use  $\frac{3}{4}$ " fittings with gaskets and a suitable tube tightening clip, with clamp screws. Connect a valve or tap before the delivery tube, so as to regulate the inflow of water.



**DO NOT INVERT CONNECTION OF THE TUBES AND MAKE SURE THE TUBES ARE NOT PINCHED OR BENT AT TIGHT ANGLES.**

**WATER FED IN WHICH IS AT A TEMPERATURE THAT IS TOO HIGH (ABOVE 28°C) WOULD PREVENT CORRECT OPERATION OF THE HEAT EXCHANGER FITTED ON THE MACHINE.**

**UNSUITABLE TUBES OR CONNECTORS MAY CAUSE LEAKS, WITH CONSEQUENT PROBLEMS IN THE WORKING ENVIRONMENT. WATER LEAKS MAY SERIOUSLY DAMAGE THE MACHINE.**

**IF THE MAINS WATER USED TO SUPPLY THE MACHINE IS HARD WATER OR CONTAINS A LOT OF IMPURITIES, INSTALL A SUITABLE DECALCIFICATION OR FILTERING DEVICE UPSTREAM OF THE DELIVERY TUBE.**

**MACHINE WATER INFEEED (IN) PRESSURE MUST BE BETWEEN 1 AND 7 BAR. IF NOT THE MACHINE WILL DEVELOP OPERATING FAULTS.**

**IF THE MACHINE WATER INFEEED (IN) PRESSURE IS ABOVE THE LIMITS ALLOWED, INSTALL A SUITABLY REGULATED PRESSURE LIMITER UPSTREAM OF THE DELIVERY TUBE. IF NOT THE MACHINE COULD BE DAMAGED AND STOP OPERATING.**

**IN TEMPERATURES BELOW 0°C IT IS ESSENTIAL TO EMPTY THE WATER FROM THE MACHINE COOLING SYSTEM. OTHERWISE IT COULD FREEZE IN IT, CAUSING SERIOUS DAMAGE.**



## 4.7 Air-cooled machine

Air-cooled machines must be installed with a minimum distance from the rear wall of at least **500 mm** to allow free circulation of condensation air.



Every day, clean the area around the machine to prevent foreign bodies (for example: build-up of dust, bits of paper, etc.) from blocking the regular inflow of air. Monthly, thoroughly clean the condenser grille, removing any dust residues, bits of paper, etc., to allow the machine to operate correctly.

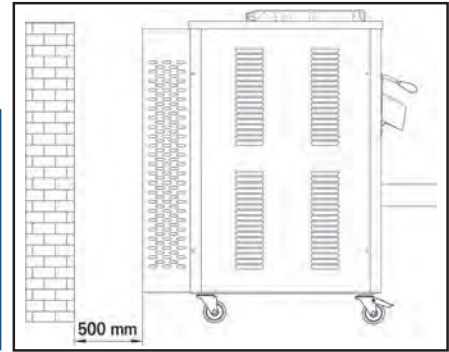

Remove dust from the condenser grilles “dry” with a vacuum cleaner and, if necessary, a brush, so that the dust is removed outwards.



**DO NOT USE LIQUIDS BECAUSE THEY WOULD FIX THE DUST ON THE CONDENSER.**



**REMOVE DUST FROM THE CONDENSER GRILLES OUTWARDS TO AVOID COMPROMISING THE PERFORMANCE OF THE REFRIGERATING SYSTEM.**



**INADEQUATE MACHINE VENTILATION COULD COMPROMISE CORRECT OPERATION AND ITS PRODUCTION CAPACITY.**



## 5 MACHINE OPERATION

### 5.1 Controls

The control panel functions are illustrated below:

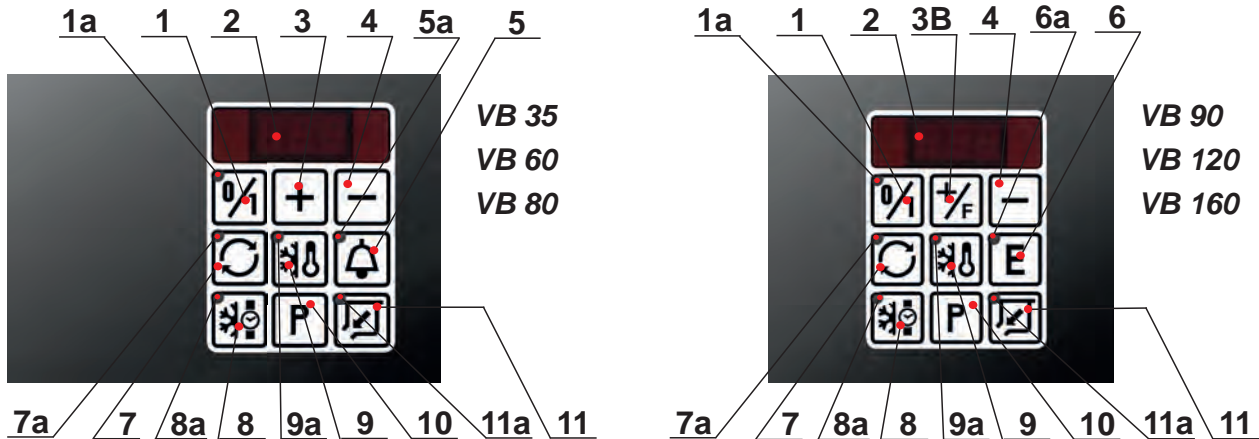

- |  |  |
|--|--|
| <p><b>1. ON/OFF button</b></p>                         | <p>For switching the machine on and off. The digital display (2) shows the temperature of the “cooling” cylinder (front cylinder).</p>   |
| <p><b>1a. Power LED</b></p>                            | <p>Power ON light. When lit the LED indicates that the machine is supplied with electricity.</p>   |
| <p><b>2. Digital display</b></p>                       | <p>Displays the machine functions and data set.</p>  |
| <p><b>3. + Adjustment button</b></p>                   | <p>This button is only active during programming functions. Pressing it increases the selected value.</p>  |
| <p><b>3B. Maintenance /Adjustment button + / F</b></p> | <p><i>Dual function button:</i><br/> a) increases the value selected in the various programming functions when pressed.<br/> b) The MAINTENANCE button functions only once the other functions have been deactivated. On being pressed, maintenance of the cylinder is activated at 0°C. For further details see Par. 5.3 – Programming.</p>   |
| <p><b>4. - Adjustment button</b></p>                   | <p>This button is only active during programming functions. Press to reduce the selected value.</p>  |
| <p><b>5. Buzzer button</b></p>                         | <p>Turns ON/OFF the acoustic signal at the end of the heating cycle. When the buzzer is ON, the warning light (5a) is lit.</p>   |
| <p><b>6. Economizer button</b></p>                     | <p>(only models VB90-120-160) The machine is provided with an energy-saving function (1 refrigerating circuit only). Press this button to enable it (the respective indicator light (6a) turns on).</p>  |
| <p><b>7. Mix button</b></p>                            | <p>Switches ON/OFF clockwise rotation of the mixer in the upper tank, in manual mode. When mixing is ON the warning light (7a) is lit.</p>   |
| <p><b>8. “TIME-BASED CYCLE” button</b></p>             | <p>Button for starting a machine “time-based” operating cycle. When the cycle is ON the warning light (8a) in the button is lit. When this button is pressed the mixer in the “front” cylinder and the machine cooling system are switched on automatically for a factory set mixing time. The time-based operating cycle ends when the mixing time set has elapsed. The cooling system switches off automatically whilst the clockwise mixing of the mixer continues to prevent the formation of ice on the sides of the cylinder. Press the button again to deactivate the cycle and stop the machine.</p> |

---

**9. “TEMPERATURE-BASED CYCLE” button** Button for starting a machine “temperature-based” operating cycle. When the cycle is ON the warning light (9a) in the button is lit. When this button is pressed the mixer in the “front” cylinder and the machine cooling system are switched on automatically. The temperature-based cycle ends when the product in the cylinder reaches the factory set cooling temperature. The cooling system switches off automatically whilst the clockwise mixing of the mixer continues to prevent the formation of ice on the sides of the cylinder. Press the button again to deactivate the cycle and stop the machine.

---

**10. Programming button** For accessing machine “cooling” cycle programming functions (see sec. 5.3 “Programming”).

---

**11. Extraction button** Starts/stops the counterclockwise rotation of the mixer inside the “front” cylinder to allow the product to come out of the extraction door at the end of the cooling cycle. When extraction is activated the warning light (11a) comes on.

---



**DO NOT PRESS THE EXTRACTION BUTTON WHEN THE MIXTURE OR PRODUCT IN THE CYLINDER IS LIQUID, BECAUSE THE HIGH ROTATION SPEED OF THE MIXER (COUNTERCLOCKWISE) WOULD MAKE THE PRODUCT COME OUT OF THE CYLINDER SUDDENLY. DO NOT PRESS THE EXTRACTION BUTTON AT THE END OF THE GRANITA PRODUCTION CYCLE, BECAUSE THE HIGH ROTATING SPEED OF THE MIXER (COUNTERCLOCKWISE) WOULD MAKE THE PRODUCT COME OUT OF THE CYLINDER SUDDENLY. PRESS THE MIX BUTTON (MIXER CLOCKWISE ROTATION) TO MAKE THE GRANITA COME OUT OF THE MACHINE CYLINDER CORRECTLY AND SAFELY.**



## 5.2 Switching on and starting the machine



**EVERY DAY, WHEN YOU SWITCH ON THE MACHINE, CHECK THAT THE SAFETY DEVICES ARE OPERATING CORRECTLY AS DESCRIBED IN DETAIL IN SECTION 8.5 OF THIS MANUAL.**

Connect the machine power cable to a socket and check that the power LED (1) is lit. Press the ON/OFF 0/1 button to prepare the machine to operate and the cylinder temperature is shown on the digital display (2).

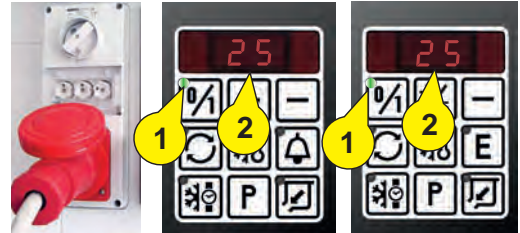

Possible machine operating modes:

1. **Production with “time”-based operating cycle**, for making gelato and sorbet.
2. **Production with “temperature”- based operating cycle**, for making gelato and sorbet.

Once the operation mode has been selected, and the pasteurised mixture or the pre-packaged food products have been placed inside the cylinder, simply press the relative start button to start the production.



**Before starting production, remember to run the machine wash phases as described in sections 6-7, “Pre-washing and Washing”, of this manual.**

**Before starting the production carry out the following checks:**

- Check that the mixer and retaining paddle locking knobs are fully tightened.



- Check that the extraction door is closed and pour the pasteurised mixture or the pre-packaged food products in the cylinder. The suitable quantity of product which can be processed is indicated in sec. 2.4, “Machine technical data” of this manual.

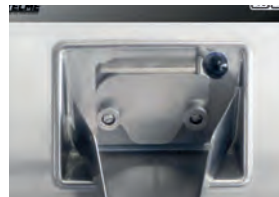

- For water-cooled machines, check that the water inlet tap is open.



- For air-cooled machines, check that the machine is positioned with the required space from the rear wall and that there are no foreign bodies obstructing the condenser air flow.



**Do not start the machine operating cycle before putting the mix in the cylinder. The mixer must not operate with no product inside it as it will be damaged.**

### 5.3 Programming (All models)



**DURING ITS FACTORY INSPECTION, THE MACHINE HAS BEEN PROGRAMMED WITH OPTIMAL TIME AND TEMPERATURE PARAMETER VALUES FOR THE OPERATION CYCLES.**

**DO NOT CHANGE PROGRAMMING UNLESS IT IS STRICTLY NECESSARY.**



**IF PARAMETER VALUES DO NEED TO BE ALTERED, MAKE ANY NECESSARY MACHINE PROGRAMMING CHANGES.**

- Check that the power LED (1) is on and press the machine ON/OFF 0/1 (A) button.
- The machine prepares itself to operate and subsequently the tank temperature is displayed on the digital display (2).
- Keep the “PROGRAMMING” (B) button pressed for a few seconds to access the programming functions.
- The functions are divided into four clearly separate categories and are identified by a flashing code that is displayed in sequence on the machine digital display.

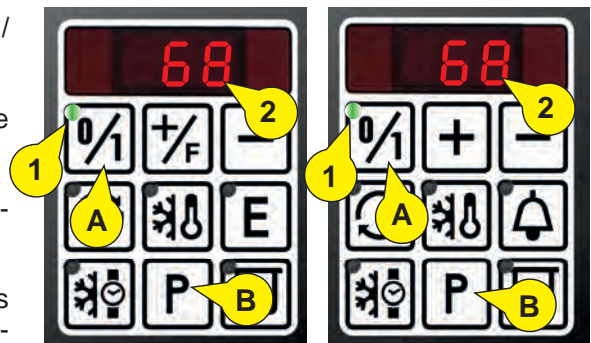

<u>Code</u>	<u>Function</u>
P1	Adjusting the temperature-based cycle 
P2	Adjusting the time-based cycle 
P3	Machine operating time
P4	Gelato retain time (only models VB90, VB120, VB160)
H-0	Machine operating time (thousands "H-0" expressed in hours)
000	Machine operating time (Hundreds, tens, units "000" expressed in hours)



**THE SWITCH BETWEEN FUNCTIONS OCCURS AUTOMATICALLY WITH A TIME INTERVAL OF 5 SECONDS. TO ACCESS THE FUNCTION TO ADJUST THE OPERATOR MUST WAIT FOR THE DISPLAY TO SHOW THE CODE ASSOCIATED TO THE DESIRED FUNCTION.**

**AT THE END OF THE PROGRAMMING CYCLE THE SYSTEM EXITS THE FUNCTIONS AUTOMATICALLY AND THE CYLINDER TEMPERATURE IS SHOWN ON THE DIGITAL DISPLAY.**





### 5.3.1 Adjusting the temperature-based cooling cycle (P1)

- Press the “PROGRAMMING” button (B) to access programming functions. The digital display shows the flashing code P1.
- Press the “PROGRAMMING” button (B) again. A number value indicating the cooling temperature set appears on the display. Press adjustment buttons (C) and (D) to increase or reduce the cooling temperature value.
- The cooling temperature can be adjusted within a range between -12°C and +6°C ( 5°F... 50 °F). The factory set value is -8,8°C (16 °F)

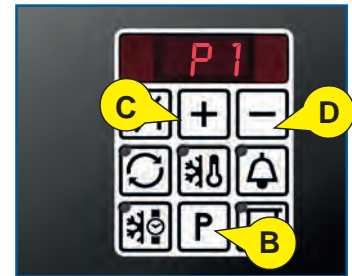

THE COOLING TEMPERATURE MUST BE PROGRAMMED ACCORDING TO THE QUANTITY OF ANTI-FREEZING INGREDIENTS (FOR EXAMPLE: SUGAR OR ALCOHOL) IN THE MIXTURE TO BE PROCESSED.



AS A GUIDE, FOR “LEAN” MIXTURES (WITH ONLY A FEW ANTI-FREEZING INGREDIENTS) A COOLING TEMPERATURE OF -5 to -6 °C (23... 21°F) SHOULD BE SET.

FOR MIXTURES WITH A MEDIUM QUANTITY OF ANTI-FREEZING INGREDIENTS A COOLING TEMPERATURE OF -7 to -8 °C (20... 18 °F) SHOULD BE SET.

FOR “RICH” MIXTURES WITH A LARGE QUANTITY OF ANTI-FREEZING INGREDIENTS A COOLING TEMPERATURE OF -9 to -10 °C (17...14°F) SHOULD BE SET.

### 5.3.2 Adjusting the time-based cooling cycle (P2)

- Then press the “PROGRAMMING” button (B). The digital display shows the flashing code P2. Press the PROGRAMMING button (B) again. The digital display shows a number value indicating the mixing time for the product processed in the cylinder. The mixing time corresponds to the length of the time-based cycle, expressed in minutes.
- Press adjustment buttons (C) and (D) to increase or reduce the mixing time value.
- The length of the time-based operating cycle can be adjusted within a range between 1 and 60 minutes. The factory set value is 8 minutes.

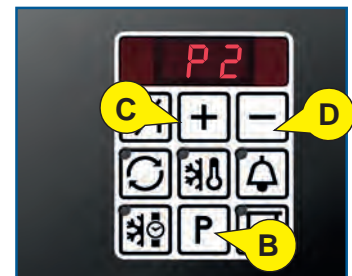



### 5.3.3 The machine operating time (P3) (only models VB 35, VB 60, VB 80)

- Press the “PROGRAMMING” button (B) again and the "P3" code (flashing) appears on the display. Press the “PROGRAMMING” button again and the machine operating time is displayed, using the text “H-0” (which corresponds to the machine operating time in thousands of hours), for example followed by the numbers “010” (indicating: hundreds, tends and units of hours of operation).

See the following examples:



#### a) 10 hours

The digital display shows H-0 followed by “010”



#### a) 250 hours

The digital display shows H-0 followed by “250”



#### b) 1250 hours

The digital display shows H-1 followed by “250”



#### c) 2250 hours

The digital display shows H-2 followed by “250”





### 5.3.4 Adjusting the buzzer (P3) (only models VB90, VB120, VB160)

- Then press the “PROGRAMMING” button (B). The digital display shows the flashing code P3. Press the “PROGRAMMING” button (B) again to view the length of the buzzer sound at the end of the cooling cycle. The factory set value is 10 seconds.
- Press adjustment buttons (C) and (D) to increase or reduce the length of the buzzer sound, expressed in seconds.
- The length of the buzzer sound can be adjusted within a range between 0 and 30 seconds.
- If a time of 0 seconds is entered, the buzzer is switched off.



### 5.3.5 Gelato retain time (P4) (only models VB90, VB120, VB160) (only with Time-based cycle production)

- Then press the “PROGRAMMING” button (B). The digital display shows the flashing code P4.
- Press the “PROGRAMMING” button (B) again will appear refrigeration circuit operating and stopping times, for the retain of the gelato (expressed in seconds), the advised time (and one which has been pre-set in the factory) for both operating and stopping is 15 seconds. The regulation field is 0” . . . 60” for both settings.
- Press adjustment buttons (C) and (D) to increase or reduce the length of the buzzer sound, expressed in seconds.



### 5.3.6 The machine operating time (P5) (only models VB 90, VB120, VB160)

- Press the “PROGRAMMING” button (B) and the "P5" code (flashing) appears on the display. Press the “PROGRAMMING” button (B) again and the machine operating time is displayed, using the text “H-0” (which corresponds to the machine operating time in thousands of hours), for example followed by the numbers “010” (indicating: hundreds, tends and units of hours of operation).
- For example (See Sec. 5.3.3).



### 5.3.7 Cylinder Temperature Retain Function (button F) (only models VB90, VB120, VB160)

- By pressing the “F” button (C) at the end of a working cycle (only with cold cylinder) the operator activates the CYLINDER TEMPERATURE RETAIN function. Use of this option is advised in cases of continuous gelato production. Once inserted, the machine keeps cylinder temperature at 0°C, and hence ready for another production cycle.



**THE CYLINDER TEMPERATURE RETAIN DOES NOT GO AT ROOM TEMPERATURE INSERTED WITH RESIDUAL OF REMAINED GELATO/WATER INSIDE OF THE CYLINDER, BECAUSE THE MIXER WOULD COME DAMAGED.**

#### ON ALL THE MODELS



When you press the “PROGRAMMING” button (B) again (or wait for a few seconds), the Display briefly shows [- -], indicating that set up data have been stored, the SET UP mode terminates and the machine is ready to be used.



## 5.4 Temperature-based cycle production

- Check that the power LED (A) is lit and press the machine ON/OFF 0/1 button.

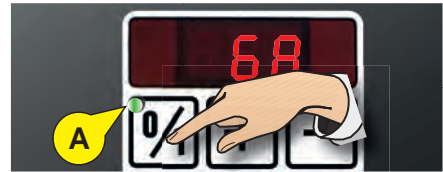

**Note:** You can check and if necessary modify the cooling temperature value, depending on the type of mix and quantities of ingredients that prevent freezing. Follow the instructions in section 5.3.1 of this manual.

THE COOLING TEMPERATURE MUST BE PROGRAMMED ACCORDING TO THE QUANTITY OF ANTI-FREEZE INGREDIENTS (FOR EXAMPLE: SUGAR OR ALCOHOL) IN THE MIXTURE TO BE PROCESSED.



AS A GUIDE, FOR “LEAN” MIXTURES (WITH ONLY A FEW ANTI-FREEZE INGREDIENTS) A COOLING TEMPERATURE OF  $-5 \div -6$  °C (23... 21°F), SHOULD BE SET.

FOR MIXTURES WITH A MEDIUM QUANTITY OF ANTI-FREEZE INGREDIENTS A COOLING TEMPERATURE OF  $-7 \div -8$  °C (20... 18 °F), SHOULD BE SET.

FOR “RICH” MIXTURES WITH A LARGE QUANTITY OF ANTI-FREEZE INGREDIENTS A COOLING TEMPERATURE OF  $-9$  to  $-10$  °C (17...14°F), SHOULD BE SET.

- Before starting the production check that the extraction door is closed and pour the pasteurised mixture or the pre-packaged food products in the cylinder.



**Note:** The suitable quantity of product which can be processed is indicated in sec. 2.4, “Machine technical data” of this manual.

- Close the cover and start the temperature-based operating cycle by pressing button (E). The mixer in the cylinder and the machine cooling system are automatically switched on simultaneously. The light in the “TEMPERATURE-BASED CYCLE” button (E) and that in the “MIX” button (F) come on.

- The cooling temperature can be adjusted within a range between  $-12$  °C and  $+6$ °C ( 5°F... 50 °F). The factory set value is  $-8,9$ °C (16 °F) (temperature suitable for making gelato and sorbet).

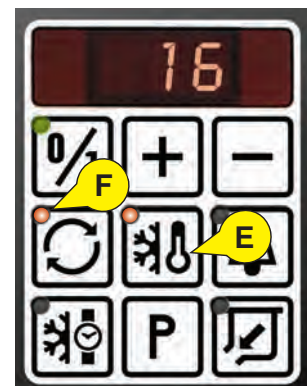



- At the end of processing, that is to say, when the product cooling temperature has been reached, the operator is alerted by a buzzer. Once the cycle has ended the cooling system switches off automatically whilst the clockwise mixing of the mixer continues to prevent the formation of ice on the sides of the cylinder.

- If it is not removed the product remains in the maintaining state (storage) in the cylinder with a factory set temperature delta of 2°C (35,6 °F). When the temperature of the product increases inside the cylinder, the cooling system starts automatically to restore the temperature set. The warning lights in the MIX button (F) and “TEMPERATURE-BASED CYCLE” button (E) remain lit to indicate that the cycle is still active.



**ONCE THE CYCLE HAS ENDED WE RECOMMEND EXTRACTING THE PRODUCT TO ENSURE THAT ITS CONSISTENCY IS NOT CHANGED BY TOO MUCH MIXING.**

- Position a suitable container on the machine basin support and open the extraction door.

- Extract the product by pressing the “EXTRACTION” button (G). When extraction is activated the warning lamp comes on.

- Use the spatula supplied to help the gelato flow into the tub.

- To end the extraction and stop the machine press the “TEMPERATURE-BASED CYCLE” button (E). The warning light for the temperature-based cycle will go out.

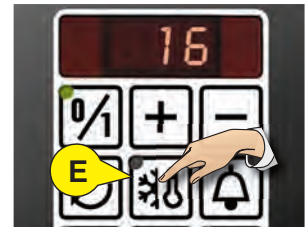

#### 5.4.1 Modifying the cooling temperature with the temperature-based cycle started

If, during the processing cycle, you want to modify the cooling temperature, this can be done by accessing the programming section. Follow the instructions in section 5.3.1 of this manual.

- Press the + Programming/Adjustment button (B) and wait until the digital display shows code “P1”.

- A few seconds after the code P1 flashes on the display, a numerical value indicating the cooling temperature set appears on the display (e.g.: -7°C / 19 °F).

- Press the adjustment buttons (C) and (D) to set the new cooling temperature for the product processed.

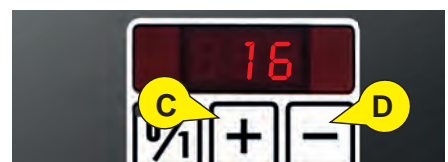



## 5.5 Time-based cycle production

- Check that the power LED (A) is lit and press the machine ON/OFF 0/1 button.



**Note:** You can check and if necessary modify the mixing time value, depending on the quantity and type of mix and the number of consecutive production runs. Follow the instructions in section 5.3.2 of this manual.

- Before starting the production check that the extraction door is closed and pour the pasteurised mixture or the pre-packaged food products in the cylinder.



**Note:** The suitable quantity of product which can be processed is indicated in sec. 2.4, "Machine technical data" of this manual.

- Close the cover and start the time-based operating cycle by pressing button (H). The mixer in the cylinder and the machine cooling system are automatically switched on simultaneously.
- The light in the "TIME-BASED CYCLE" button (H) and that in the "MIX" button (F) come on.
- The length of the time-based operating cycle can be adjusted within a range between 1 and 30 minutes. The factory set value is 8 minutes.
- At the end of processing, that is to say, when the mixing time set has elapsed, the operator is alerted by a buzzer, the letter "t" appears on the display. Once the cycle has ended the cooling system switches off automatically whilst the clockwise mixing of the mixer continues to prevent the formation of ice on the sides of the cylinder.
- The warning lights in the MIX button (F) and "TIME-BASED CYCLE" button (H) remain lit to indicate that the cycle is still active.



**ONCE THE CYCLE HAS ENDED WE RECOMMEND EXTRACTING THE PRODUCT TO ENSURE THAT ITS CONSISTENCY IS NOT CHANGED BY TOO MUCH MIXING.**

- Position a suitable container on the machine basin support and open the extraction door.
- Extract the processed product (gelato) by pressing the “EXTRACTION” button (G).
- When extraction is in progress the warning light is lit.
- To end the extraction and stop the machine press the “TIME-BASED CYCLE” button (H). The warning light for the time-based cycle will go out.

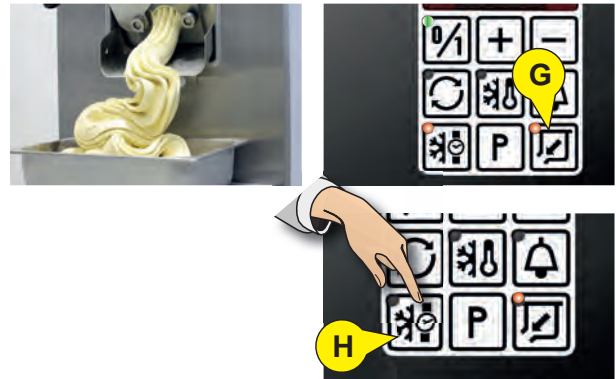

### 5.5.1 Modifying the mixing time with the time-based cycle started

If, during the processing cycle, you want to modify the mixing time, this can be done by accessing the programming section. Follow the instructions in section 5.3.2 of this manual.

- Press the + Programming/Adjustment button (B) and wait until the digital display shows code “P2”.
- A few seconds after the code P2 flashes on the display, a numerical value indicating the time set appears on the display.
- Press the adjustment buttons (C) and (D) to set the new mixing time for the product processed.







## 6 PRE-WASHING



Do not carry out the rinsing having a very cold cylinder.

- Proceed with rinsing to eliminate the residual ice-cream, using 3 gal.(VB 35), 5 GAL.(VB 60),7 gal.(VB 80 and VB 90),10 gal.(VB 120), 11 gal.(VB 160) of warm water(30°C), if you soon will produce other ice-cream;
- Proceed with rinsing to eliminate the residual ice-cream, using 3 gal.(VB 35), 5 GAL.(VB 60),7 gal.(VB 80 and VB 90),10 gal.(VB 120), 11 gal.(VB 160)of warm water (30°C) and, if the production has come to an end, proceed with simple washing, accurate washing and disassembling of the parts (see 7 WASHING).

## 7 WASHING



The fats contained in the ice-cream mixtures are ideal for the growth of bacteria. we recommend to wash and sanitize with the maximum care every part in contact with product, In accordance with current health regulations.



For a long life of the device we suggest not to use solvents, abrasive detergents, or rough sponges, in particular on the plastic and rubber parts. During the washing operations and in particular during the rinsing, activate the beating only for the suggested periods. Otherwise you could damage the machine. DO NOT press the Temperature-based cycle button (E) or Time-based cycle button (H) during the washing. Otherwise you would freeze the water and break the parts of the machine. Do not press the EXTRACTION Pushbutton (G) because all the washing solution would come out from the top of the machine. Do not carry out the washing having a very cold cylinder.

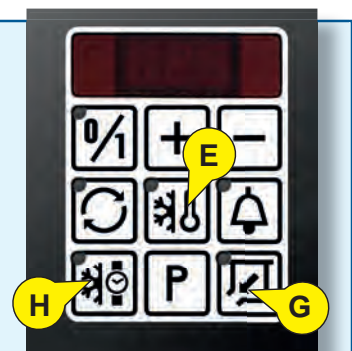

## 7.1 Simple washing



**ALWAYS WEAR SUITABLE PROTECTIVE GLOVES.**

### STEP 1

- Prepare a pail with a solution composed by hot water (Maxim 50°C)(Maxim 122°F) and detergent GOLDEN GLO by SPARTAN CHEMICAL, respecting the following amount:
- for models VB 35 use 3 gallons of hot water and 1,1/2 oz. of detergent;
- for models VB 60 use 5 gallons of hot water and 2,1/2 oz. of detergent;
- for models VB 80, VB 90 use 7 gallons of hot water and 3,1/2 oz. of detergent;
- for models VB 120 use 10 gallons of hot water and 5,1/2 oz. of detergent;
- for models VB 160 use 11 gallons of hot water and 6 oz. of detergent;



### STEP 2

- Check that the extraction door is closed, open lid, pour the detergent solution in the cylinder and close the lid again.



### STEP 3

- Press the MIX button (F), this will cause the detergent solution to be agitated in the cylinder.

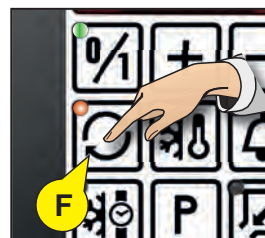

### STEP 4

- 2 minutes later, press the MIX button (F) again to stop the mixer, position the water collection container supplied (V), on the machine basin support (20). Gradually open the extraction door (15) with the lever (18) and let the disinfectant solution flow out.



### STEP 5

- Rinse only with hot potable water (Max.50°C)(Max. 122°F), repeating steps 2,3,4 until the rinse water being drawn from the cylinder is clear.



## 7.2 Accurate washing and disassembling of the parts



Carry out these operations only with the socket's main Breaker on POSITION "0".  
The (1) indicator of the Ignition button on the control panel must be turned off.



### STEP 1

#### • Removing the cover

- Pull the fixing pin (1) out of the block horizontally and remove the cover (2).



#### • Removing the retaining paddle

- Unscrew the fixing knob (3) and remove the retaining paddle (4).
- Take out the safety stop (5) and remove the movable part (6) of the retaining paddle.
- Remove the gasket (7) from the fixing knob (3) using a non-metallic pointed tool, taking care not to damage the knob seat.

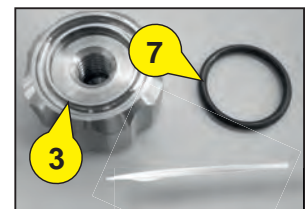
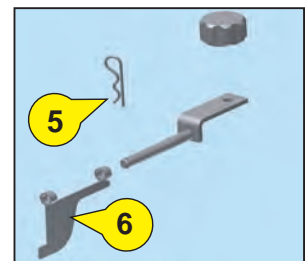

**RESIDUAL HAZARD: Mixer's blades and scrapers are sharp along bottom and external side edges. It is recommended to use suitable protective gloves and to handle the mixer only by holding the central hub and not the blades.**

#### • Removing the mixer

- Unscrew the fixing knob (8), grip the mixer component drive and pull the mixer (9) out vertically.
- Remove the gasket (10) from the fixing knob (8) using a non-metallic pointed tool, taking care not to damage the knob seat.

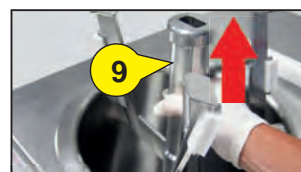
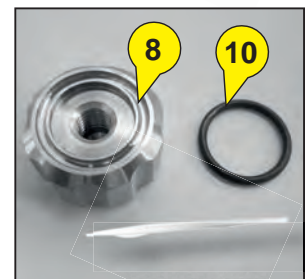

#### • Removing the mixer scrapers

- Remove the side scrapers (11) using the tool supplied (12). Insert the tool under the scraper and prise off by pushing the tool down until the side scraper can be removed from its seat.
- Pull the mixer's lower scraper (13) from its seat.



#### • Removing the extraction door

- Unscrew counterclockwise the fixing knobs (14) and extract the extraction door (15), using a provided allen key (16), unscrew the tightening screw (17) and remove the lever (18). Remove the flat springdriver (26) and big spring (27), the conic springdriver (28) and small spring (29).

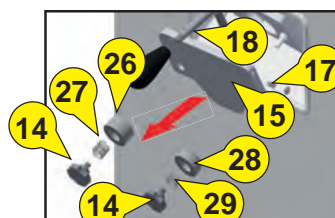



• **Removing the mat and basin support**

- Remove the mat (21) located on top of the basin support (20), then remove the basin support (20) by undoing the 2 fixing screws (30) underneath it.

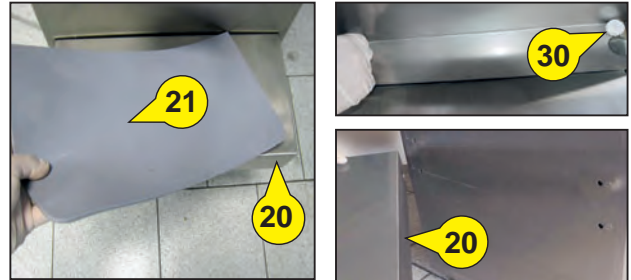

• **Removing the extraction door chute**

- Unscrew the clamp screws (30) under the extraction door chute (19) and remove it.
- Remove the extraction door chute gasket (19a) by pulling it out of its seat.

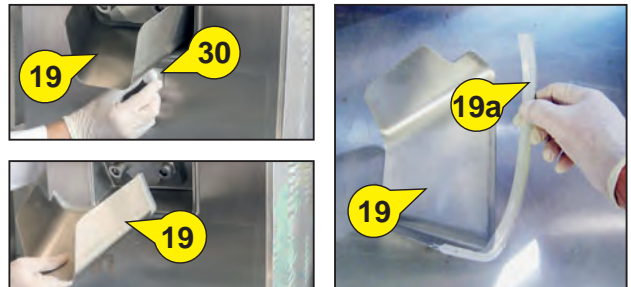

**STEP 2**

Prepare a pail with a solution composed by 1 gal. (1 1/2 gal. VB 120 and VB160) of room temperature water and 1/4 oz. (3/8 oz. VB120 and VB160) of disinfecting SANI-T-10 manufactured by SPARTAN CHEMICAL and carry out the cleaning of the underlisted parts, using the provided brushes (Z) as illustrated in the images.

- the mixer (9) and the fixing knob (8);
- the side scrapers (11) and the lower scraper (13);
- the cover (2);
- the extraction door (15);
- the extraction door chute (19);
- the basin support (20) and mat (21);
- the retaining paddle support (22), the safety peg (23), the fixing knob (24) and the movable blade (25)

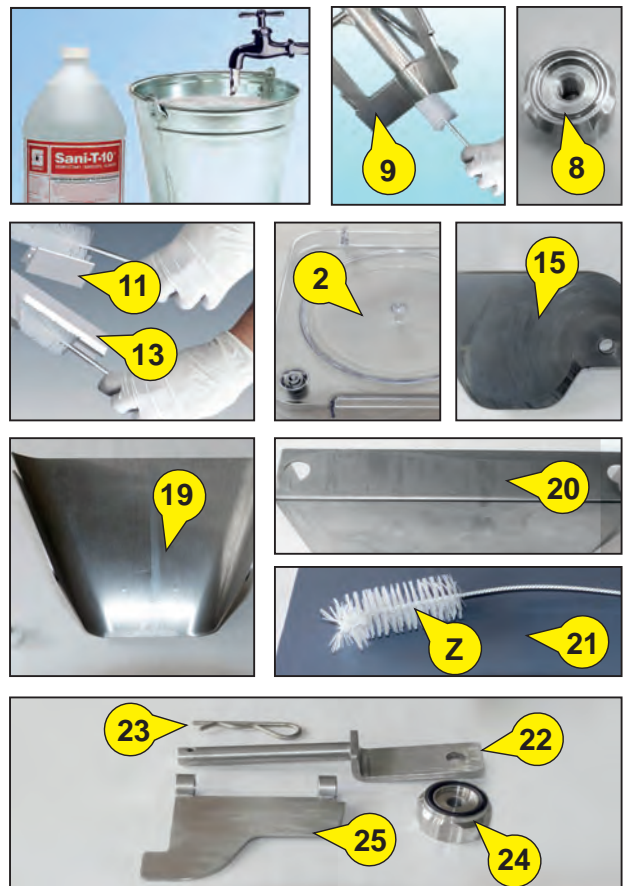



### STEP 3

Prepare a pail with a solution composed by 3 gal. (4 gal.VB 120) (5 gal.VB160) of water and 3/4 oz. (1 oz. VB120) (1,1/4 oz.VB160)of disinfecting SANI-T-10 manufactured by SPARTAN CHEMICAL and immerse for at least 5 minutes the under-listed parts:

- the fixing knobs (8) and (24);
- the extraction door (15);
- the extraction door chute (19);
- the flat springdrive (26) with relative big spring (27);
- the conic springdrive (28) with relative small spring (29);
- the mixer (9);
- the side scrapers (11) and the lower scraper (13);
- the retaining paddle support (22);
- the movable blade (25) and the safety peg (23);

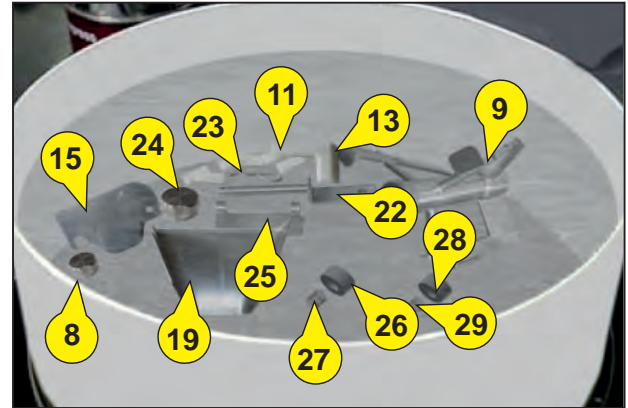

### STEP 4

Before reassembling the components, accurately wash the fixed parts of the device as illustrated in the drawings and under-listed, using the solution previously prepared (see STEP 2).

- the extraction pipe (Y), the safety grill, the groove and its edges using the provided brush (Z).
- the upper surface, the lid's rod and the inside of the cylinder;

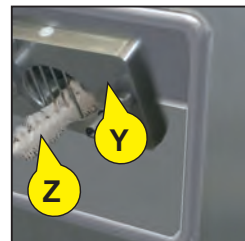

### STEP 5

A potable water rinse is not necessary unless so specified by state or local ordinance.

### 7.3 Reassembly



These operations must be carried out only with the socket's main breaker on "0".



ALWAYS WEAR NEW SUITABLE PROTECTIVE GLOVES.

#### STEP 1

After carrying out the washing as previously described, reinstall the machine's parts as follows:

##### • Re-fitting the mixer scrapers

- Re-fit the side scrapers (11) by fitting them onto the pins (20) on the mixer.
- Fit the mixer's lower scraper (13) in its seat.

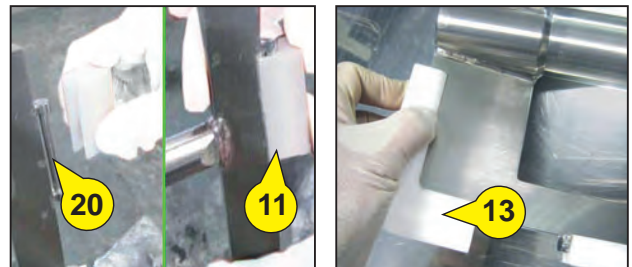

##### • Re-fitting the mixer in the cylinder

- Fit the mixer (9) on the motor-driven shaft at the centre of the cylinder.

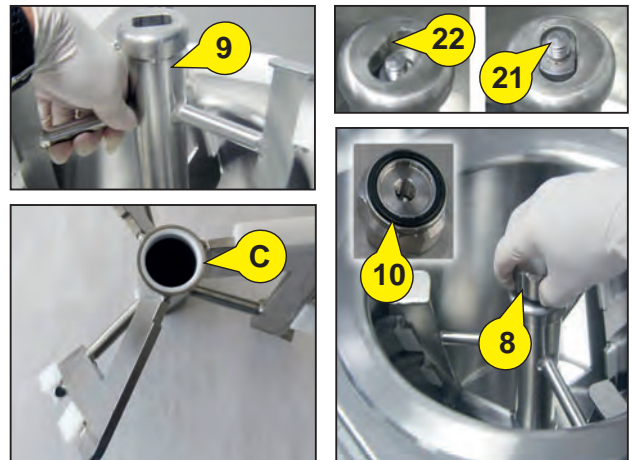

To avoid vibrations and/or damaging parts, the mixing impeller drive must be complete with its bushing (C) before inserting it on the motor shaft support.

- Slowly turn the mixer component drive so that the pin (21), which is part of the shaft structure, engages in the slot (22) made in the mixer component drive.
- Before screwing the fixing knob (8) onto the shaft, check that the gasket (10) is correctly inserted in its seat. If it is broken, worn or swollen, substitute it. Tighten the mixer knob (8).



• **Re-fitting the retaining paddle**

- Fit the movable part (6) on the support of the retaining paddle and position the safety stop (5).
- Position the retaining paddle (4) in the seat and use the knob (3) to secure it to the machine work surface.
- Before tightening the fixing knob (3), check that the gasket (7) is correctly inserted in its seat. If it is broken, worn or swollen, substitute it.

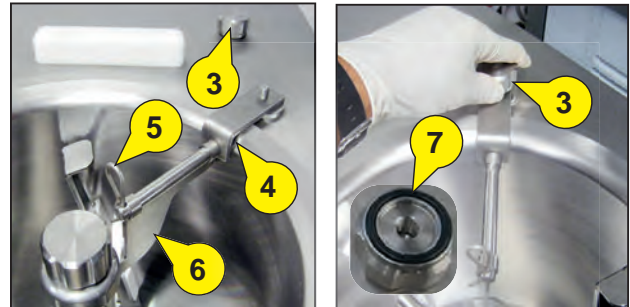

• **Re-fitting the cover**

- Place the cover (2) over the machine cylinder and line up the holes in the cover with the through hole in the block.
- Insert the fixing pin (1) to secure the cover to the machine.
- Check that the fixing pin is completely inserted in the holes in the cover and the block.

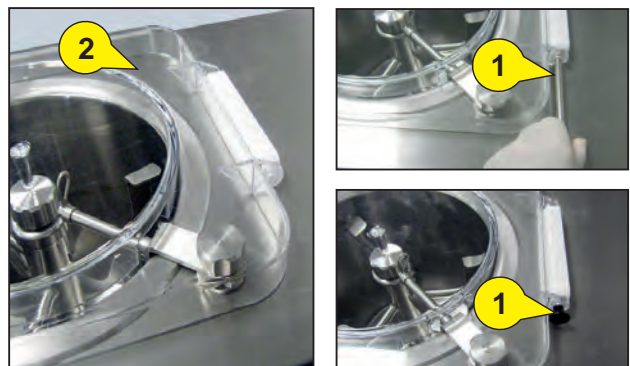

**THE INCORRECT INSTALLATION OR CONTACT FAILURE OF THE MAGNET ON THE COVER ACTIVATES A MACHINE ALARM, PREVENTING IT FROM STARTING.**

• **Re-fitting the extraction door**

- fix the lever (18) to the locking door (15) unscrewing the tightening screw (17) with a provided allen key (16);
- install the locking door (15) as illustrated in the image, taking care not to damage it, not to touch its internal surface (X) in contact with the extraction pipe (Y);
- reinstall the flat springdriver (26) with the relative big spring (27) and the fixing knob (14) on the left side, the conic springdriver (28) with the relative small spring (29) and the fixing knob (14) on the right side;

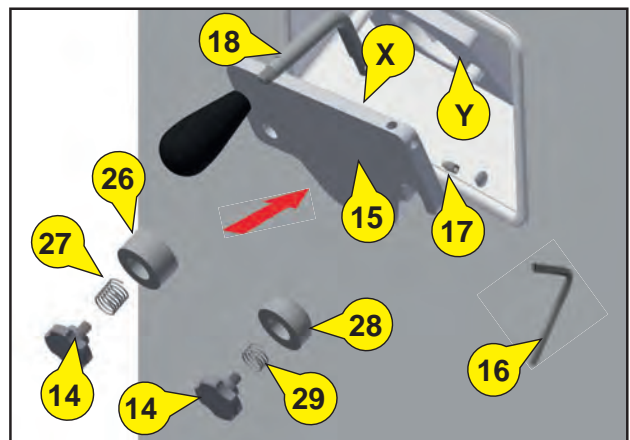



• **Re-fitting the extraction door chute**

- Insert the extraction door chute gasket (19a) in its seat.
- Position the extraction door chute (19) below the extraction door (15) and secure it by tightening the clamp screws (30) to the front panel.

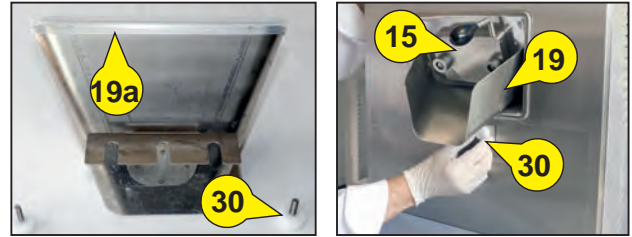

**TIGHTEN THE FIXING SCREWS, CHECKING THAT THERE IS NO PLAY IN THE CHUTE.**



**THE INCORRECT INSTALLATION OR CONTACT FAILURE OF THE MAGNET ON THE COVER ACTIVATES A MACHINE ALARM, PREVENTING IT FROM STARTING.**

• **Re-fitting the basin support and mat**

- Fit the two slots in the basin support (20) over the clamp screws (30) partly tightened on the front panel. When the basin support (20) is in place, tighten the screws (30).
- Place the mat (21) on the basin support (20).

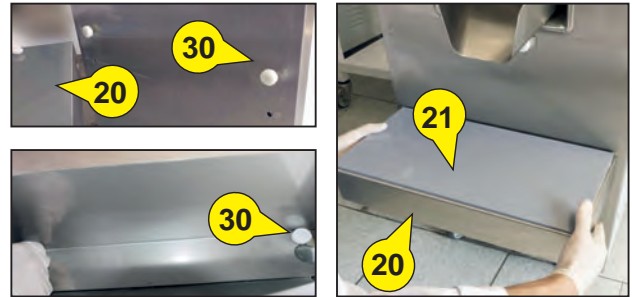

**7.4 Sanitization**

After re-fitting all of the components in the machine, carry out the sanitization with water solution and disinfecting SANI-T-10 manufactured by SPARTAN CHEMICAL. Follow accurately the next steps:

**STEP 1**

- Prepare a pail with a solution composed by room temperature water and disinfecting SANI-T-10, respecting the following dosings:
- for models VB 35 use 3 gallons of water and 3/4 oz. of disinfecting SANI-T-10;
- for models VB 60 use 5 gallons of water and 1, 1/4 oz. of disinfecting SANI-T-10;
- for models VB 80, VB 90 use 7 gallons of water and 1,3/4 oz. of disinfecting SANI-T-10;
- for models VB 120 use 10 gallons of water and 2, 1/2 oz. of disinfecting SANI-T-10;
- for models VB 160 use 11 gallons of water and 2,3/4 oz. of disinfecting SANI-T-10;





**STEP 2**

- Check that the extraction door is closed, open lid, pour the solution in the cylinder and close the lid again.



**STEP 3**

- Press the MIX button (F), this will cause the sanitizing solution to be agitated in the cylinder.

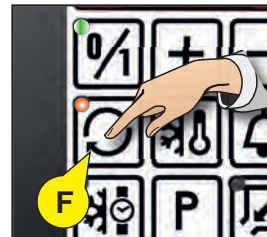

**STEP 4**

- 5 minutes later, press the MIX button (F) again to stop the mixer, position the water collection container supplied (V), on the machine basin support (20). Gradually open the extraction door (15) with the lever (18) and let the disinfectant solution flow out.

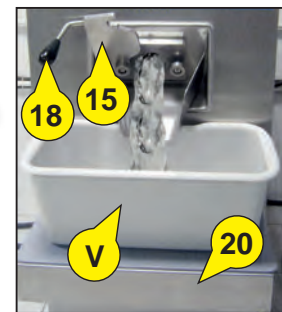

**STEP 5**

- A potable water rinse is not necessary unless so specified by state or local ordinance.



After the sanitization, close the lid and do not touch with the hands anymore, nor dry with clothes or paper all parts in direct contact with food.



Additionally to the operations mentioned in this Chapter, it is recommended to clean machine's outer panels and all of its outside parts.

## 8 ROUTINE MAINTENANCE



**ONLY PURCHASE AND USE ORIGINAL SPARE PARTS, WHICH ARE GUARANTEED BY THE MANUFACTURER. CONTACT THE DEALER OR THE NEAREST SERVICE CENTRE TO REPLACE FAULTY OR DAMAGED COMPONENTS.**

### 8.1 Type of checks and interval between them

Regular checks of the operation of the parts of the machine most subject to stresses and wear can prevent faults and help to maintain maximum productivity levels, guaranteeing lasting constant operation.

### 8.2 Maintenance work

Maintenance is the set of organised operations which must be carried out on machine parts in a regular, systematic way.



**Routine adjustment and maintenance operations carried out by the operator must be performed with the machine disconnected from the mains power supply.**

Routine maintenance:

- 1) checking the integrity of wear parts, such as scrapers and gaskets.
- 2) checking that the machine reaches and maintains the programmed temperatures without difficulty.
- 3) checking that the machine does not make any unusual noises.
- 4) keeping outer panels and the area near to and under the machine clean. Dust, scraps of paper or other small objects may get into the equipment through the air inlets and/or block the regular inflow of air to the condenser, quickly compromising correct machine operation.

### 8.3 Maintenance intervals and time needed

The interval calculated for each piece of maintenance work and the time needed to do the work are approximate and allow the creation of a maintenance programme.

Correct machine operation can only be guaranteed by methodical, regular maintenance.

The table below shows the type of work involved in routine maintenance and the intervals between jobs:

When?	Where?	How?
Every 500 hours or quarterly	Scrapers on the mixer	Replace
Every 500 hours or quarterly	Mixer guide bushing	Replace
Every 500 hours or quarterly	Gaskets on the fixing knobs and on the extraction door chute	Replace
Daily (at machine switch on)	Safety devices installed	Check that they work with the procedures described in section 8.5
Yearly	All internal machine parts	They must be checked and tested by a qualified technician



## 8.4 Maintenance sheets

### Substitution of scrapers installed on mixer

S01

CHECKING INTERVAL: 500 hours or quarterly

AUTHORISED OPERATOR: 1 Operator

TIME NEEDED: 15 minutes

TOOL: Tool supplied

Optimum scraping of the cylinder allows good machine performance and product quality.



**Substitute the mixer scrapers when they show signs of wear which are obvious when looking at their scraping profiles and also indicated by the formation of streaks of product residue on the surface of the cylinder.**

The standard mixer (A) has several parts made of food-safe plastic, which can be split into two types:

- side scrapers (B), snap-on.
- lower scraper (C), slide-on.

– **Substitute as follows:**

#### Side scrapers

- Use the tool supplied (D). Insert it under the scraper to be replaced (B) and prise the scraper off by pushing the tool down. You can now remove the scraper from its seat and replace it with a new one (E).
- Position the new scraper (E) on the pin (F) then apply a slight pressure to fit it.

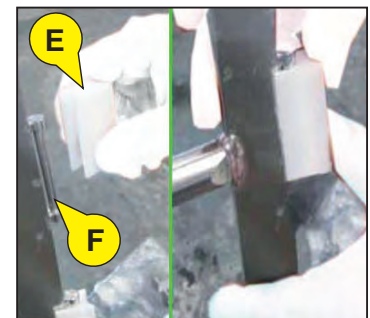
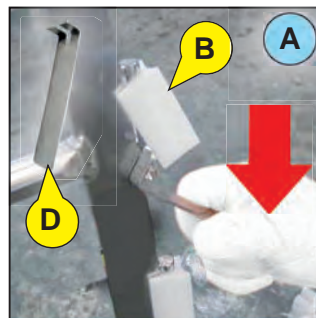

#### Lower scraper

- Pull the slide-on lower scraper (C) off the mixer structure then fit a new one (G).

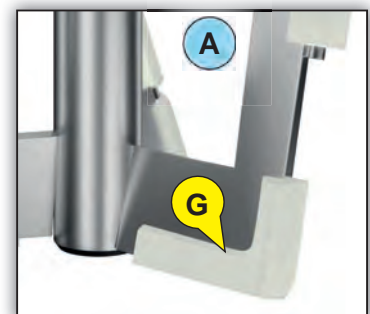

## Replacing the gaskets

CHECKING INTERVAL: 500 hours or quarterly

AUTHORISED OPERATOR: 1 Operator

TIME NEEDED: 5 minutes

TOOL: Non-metallic pointed tool

- Regularly check the integrity of the gaskets and substitute them if they are broken, worn or swollen.
- Only use original gaskets, made of food-safe rubber.
- The machine is supplied with a full set of spare gaskets.



**DO NOT PUT GASKETS IN THE INDUSTRIAL DISHWASHER, AS THE HIGH TEMPERATURES COULD DEFORM THEM, MAKING THEM UNUSABLE.**



**FOR CORRECT GASKET CLEANING, USE A DISPOSABLE CLOTH AND A DETERGENT FOR ITEMS AND MACHINES USED FOR FOOD PREPARATION.**



### Fixing knob gasket

- Remove the worn gasket (A) from the fixing knob (B) using a non-metallic pointed tool, taking care not to scratch the knob seat.
- Remove all product residues from the seat and fit the new gasket (C) **without lubricating it**.

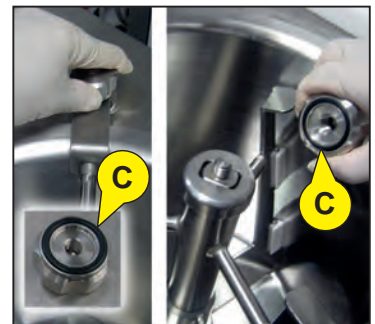
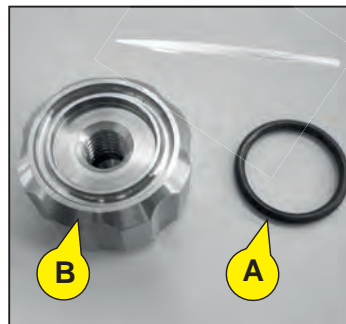

### Extraction door chute gasket

- Remove the worn gasket (D) from the extraction door chute (E) by pulling it from the metal seat.
- Replace it with a new one (G)

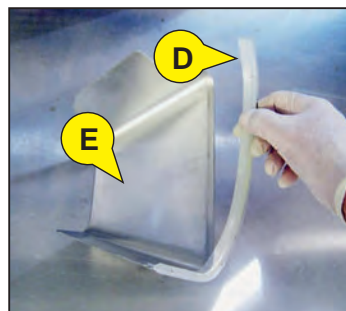





## Replacing the mixer guide bushing

S03

CHECKING INTERVAL: 500 hours or quarterly

AUTHORISED OPERATOR: 1 Operator

TIME NEEDED: 5 minutes

TOOL: -

- Periodically check that the mixer guide bushing is intact and replace it if damaged or worn.
- Only use original spare parts.



Replace the bushing for the mixer component drive when there are signs of wear.

### Mixer guide bushing

- Remove the bushing to be replaced (A) from the mixer component drive (B).

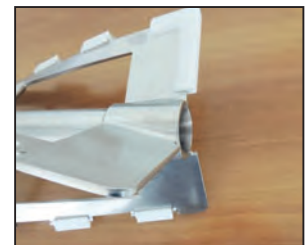
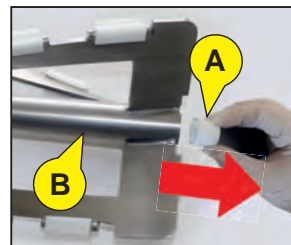

- Insert the new bushing (C) into the mixer component drive (B).

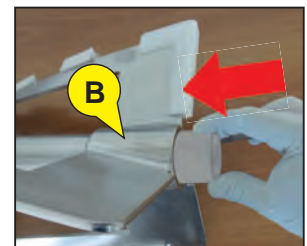
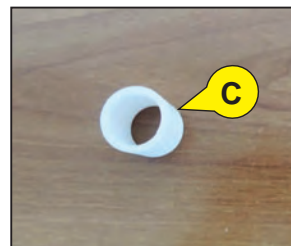

**TO AVOID VIBRATIONS AND/OR DAMAGING PARTS, THE MIXER COMPONENT DRIVE MUST BE COMPLETE WITH ITS BUSHING BEFORE INSERTING IT ON THE MOTOR SHAFT SUPPORT.**

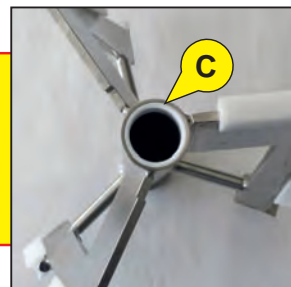

## 8.5 Checks on safety devices

### Safety devices

CHECKING INTERVAL: DAILY (AT MACHINE SWITCH ON)

AUTHORISED OPERATOR: 1 Operator

TIME NEEDED: 5 minutes

TOOL: -



**DO NOT USE THE MACHINE IF ONE OR MORE SAFETY DEVICES MALFUNCTION OR ARE DAMAGED!**

### 8.5.1 Checking the safety device installed on the cover

#### Checking procedure:

#### Phase 1

With the machine empty remove the mixer from the cylinder, close the cover and start the machine by pressing the “on/off 0/1” button. Then press the “MIX” button (A) and check that the motor-driven shaft starts up.

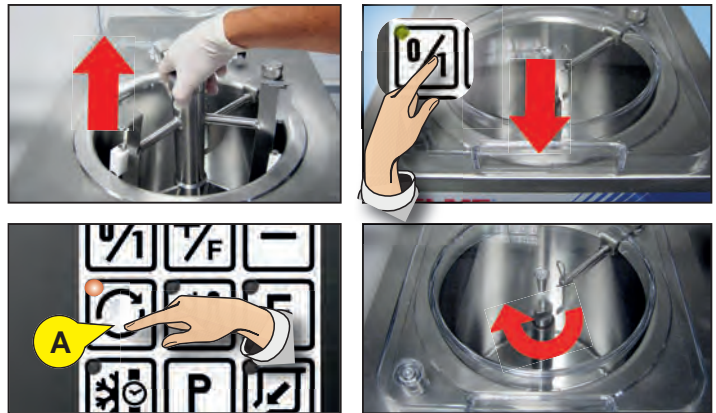

#### Phase 2

Open the cover. If the safety device is operating correctly, the shaft will stop moving and the digital display will show an alarm message: “□□□”.



#### Phase 3

Close the cover again and press the MIX button (A) to stop the motor-driven shaft. Open the cover again and install the mixer in the cylinder, so that the machine is ready for use.

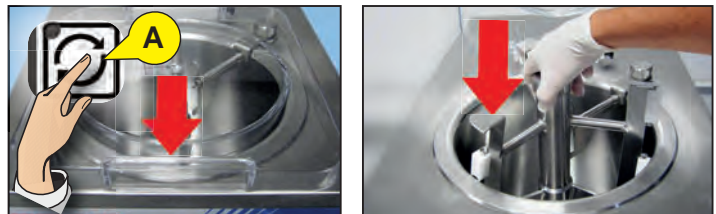





---

## 9 TROUBLESHOOTING

Most faults and problems during machine operation are promptly automatically indicated by the machine.





**ALARMS STOP THE MACHINE, WITH AN EMERGENCY STOP MESSAGE DISPLAYED ON THE CONTROL PANEL. TO RESTART THE MACHINE, YOU MUST ELIMINATE THE CAUSE OF THE EMERGENCY.**

### People involved in troubleshooting:



- **Operator:** person trained in the ordinary operation of the machine who performs initial fault-finding and if possible, by following the instructions in Chapter 8 (Routine maintenance), removes the causes of the fault and restores correct machine operation.
- **Technical assistance service:** qualified technician, called to work on the machine after a request for help, as specified in sec. 1.3.3 of this manual.





## 9.1 General alarm indications displayed on the control panel – causes and solutions

This section shows the machine alarms, which can be viewed on the digital display, together with possible causes and solutions.

<b>FAULT/ PROBLEM</b>	<b>INSTRUCTIONS FOR THE OPERATOR</b>	<b>POSSIBLE CAUSES</b>	<b>SOLUTIONS</b>
<p><b>! General alarm warning</b> “□□□”:</p> 		<ul style="list-style-type: none"> <li>• The cover on top of the cylinder is not closed correctly or tends to open. The product lifts the cover because of an excessive quantity or an excessive increase in volume.</li> <li>• The magnet and/or the magnetic sensor in the cover are damaged and/or faulty.</li> <li>• Pressure increase in the machine refrigeration system. The refrigeration system safety pressure switch tripped because the maximum pressure allowed was exceeded.</li> </ul>	<ul style="list-style-type: none"> <li>◆ Use lower quantities of product. The suitable quantity of product which can be processed is indicated in sec. 2.4 “Machine technical data”.</li> <li>◆ Contact the Technical Assistance Service which will correctly re-fit or substitute the door magnet or magnetic contact.</li> </ul> <p><b>A) For water-cooled machines:</b></p> <ul style="list-style-type: none"> <li>◆ Check that the water tap is open and water flows in correctly, as indicated in sec. 2.4 “Machine technical data”. Check that the mains water flow rate, temperature and pressure conform to the indications in sec. 2.4 “Machine technical data”. Check that there are no narrowings in the water in/out tubes. Remove any narrowing found.</li> </ul> <p><b>B) For air-cooled machines:</b></p> <ul style="list-style-type: none"> <li>◆ Check for obstructions in front of the air condenser grilles. If there are obstructions present, they must be removed. Check that the machine is positioned at the correct distance from the walls, as indicated in the manual. If it is not, reposition it in compliance with the distances indicated in sec. 4.3 “Spaces needed for use of the machine”.</li> </ul>  <p><b>To reset the thermal protections press the button located on the front of the machine.</b></p> <p><b>If the problem cannot be solved, contact the Technical Assistance Service.</b></p>



<b>FAULT/ PROBLEM</b>	<b>INSTRUCTIONS FOR THE OPERATOR</b>	<b>POSSIBLE CAUSES</b>	<b>SOLUTIONS</b>
<p><b>! General alarm warning</b> “□□□”:</p> 		<ul style="list-style-type: none"> <li>• A fuse designed to protect the auxiliary electrical system has blown.</li> <li>• Current overload in the compressor electrical circuit. The electric protection device for the refrigerating system compressor tripped.</li> <li>• No voltage in a phase of the power circuit. In these conditions the compressor generates an electric overload on the other phases, tripping its electric protection device.</li> </ul>	<ul style="list-style-type: none"> <li>◆ Contact the Technical Assistance Service which will identify and eliminate the cause of the overload and will substitute the blown fuse with another having the same specifications and level of protection.</li> <li>◆ Switch off the machine, wait a few minutes, then switch it on again. If the fault persists or is repeated, contact the Technical Assistance Service.</li> </ul> <div style="border: 1px solid red; padding: 5px; background-color: #e0f2f1;"> <p><b>Note:</b> In some cases you may need to wait for up to 30 minutes for the thermal protection devices to cool down.</p> </div> <ul style="list-style-type: none"> <li>◆ Switch off the machine and contact the Technical Assistance Service.</li> </ul> <div style="border: 1px solid yellow; padding: 5px; background-color: #fff9c4;"> <p><b>⚠ THE OTHER PHASES COULD BE LIVE. THE MACHINE MOTORS WILL BE DAMAGED IF THEY OPERATE WITH ONE OF THE PHASES NOT POWERED.</b></p> </div> <ul style="list-style-type: none"> <li>◆ Check that the product in the cylinder is not excessively solid as to cause mechanical stress to the mixer motor. Switch off the machine, wait a few minutes, then switch it on again. If the fault persists or is repeated, contact the Technical Assistance Service.</li> </ul> <div style="border: 1px solid red; padding: 5px; background-color: #e0f2f1;"> <p><b>Note:</b> In some cases you may need to wait for up to 30 minutes for the thermal protection devices to cool down.</p> </div> <p>To reset the thermal protections press the button located on the front of the machine.</p>  <p>If the problem cannot be solved, contact the Technical Assistance Service.</p>

FAULT/ PROBLEM	INSTRUCTIONS FOR THE OPERATOR	POSSIBLE CAUSES	SOLUTIONS
<p><b>! Alarm warning "P--"</b></p> 		<ul style="list-style-type: none"> <li>• The cylinder temperature probe signals a temperature higher than the safety limits. Faulty temperature probe (interrupted or out of tolerance) and/or related wiring damaged.</li> </ul>	<ul style="list-style-type: none"> <li>◆ Contact the <i>Technical Assistance Service</i>.</li> </ul>
<p><b>! Alarm warning "PE"</b></p> 		<ul style="list-style-type: none"> <li>• The cylinder temperature probe signals a temperature lower than the safety limits. Faulty temperature probe (interrupted or out of tolerance) and/or related wiring damaged.</li> <li>• The control circuits do not allow disconnection of power for the compressor (which keeps operating). The related control contactor is probably jammed.</li> <li>• There is little product in the cylinder with the cooling phase active (ice forming on the walls of the cylinder).</li> </ul>	<ul style="list-style-type: none"> <li>◆ Contact the <i>Technical Assistance Service</i>.</li> <li>◆ Contact the <i>Technical Assistance Service</i>.</li> <li>◆ <i>Switch off the machine, wait until normal operating conditions are restored and add the quantity of product which can be processed, indicated in sec. 2.4 "Machine technical data"</i>.</li> </ul>



FAULT/ PROBLEM	INSTRUCTIONS FOR THE OPERATOR	POSSIBLE CAUSES	SOLUTIONS
<p><b>! UNSUAL NOISINESS.</b></p>		<ul style="list-style-type: none"> <li>● A layer of ice has developed between the mixer and the cylinder: the mixture is not idoneous, or is not sufficient.</li> <li>● Check that the side scrapers are not worn.</li> <li>● The mixer and/or the cylinder are damaged or excessively worn.</li> <li>● The mixer and/or the cylinder have gone through a sudden temperature change, and stress mechanically.</li> </ul>	<ul style="list-style-type: none"> <li>◆ <i>The suitable quantity of product which can be processed is indicated in sec. 2.4, "Machine technical data" of this manual.</i></li> <li>◆ <i>If they appear worn, replace them.</i></li> <li>◆ <i>Contact the Technical Assistance Service.</i></li> <li>◆ <i>Switch off the machine and wait a few minutes.</i></li> </ul>

## 9.2 Troubleshooting – flowchart

In abnormal conditions the machine may malfunction, as specified below:

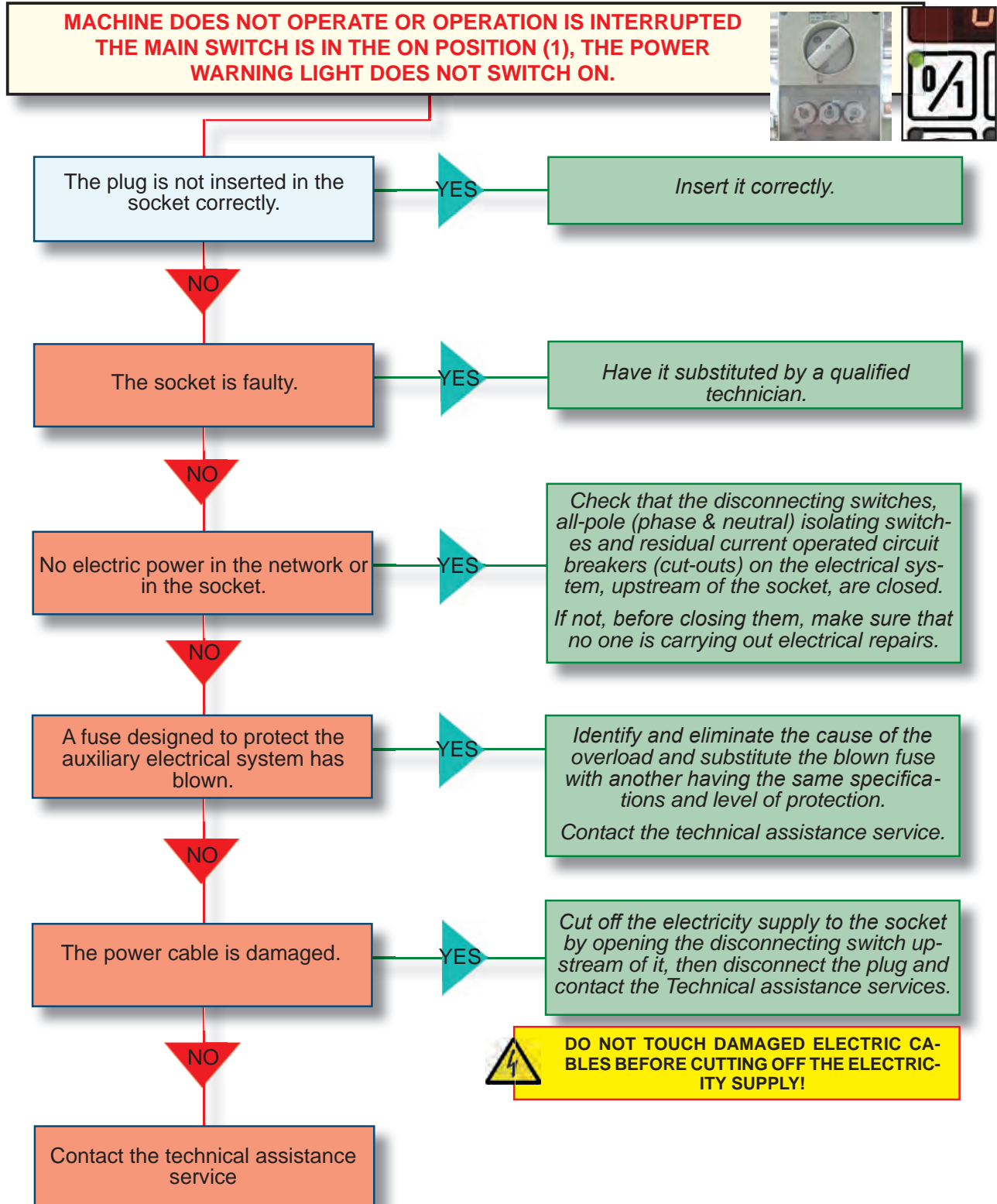

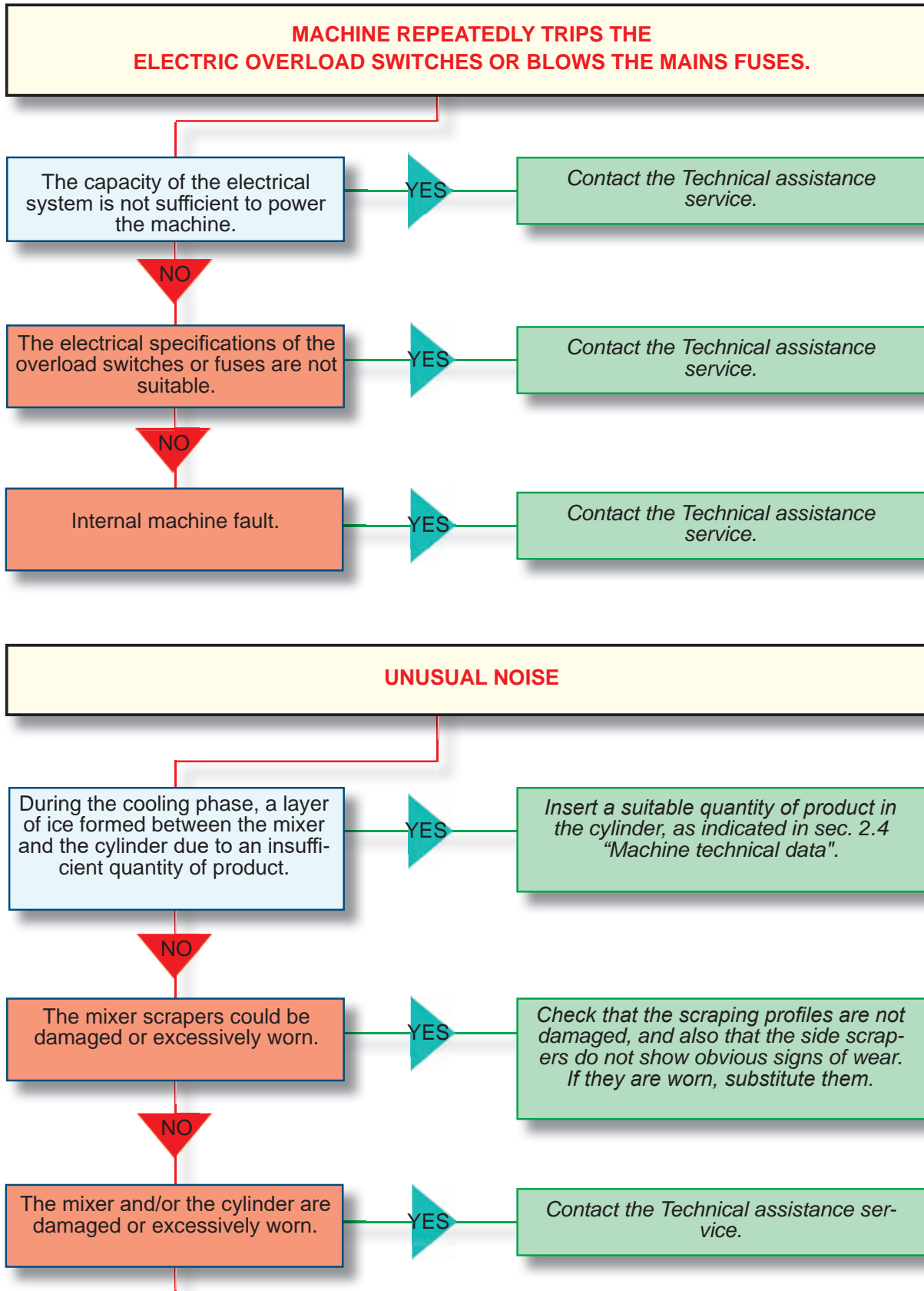



**UNUSUAL NOISE**

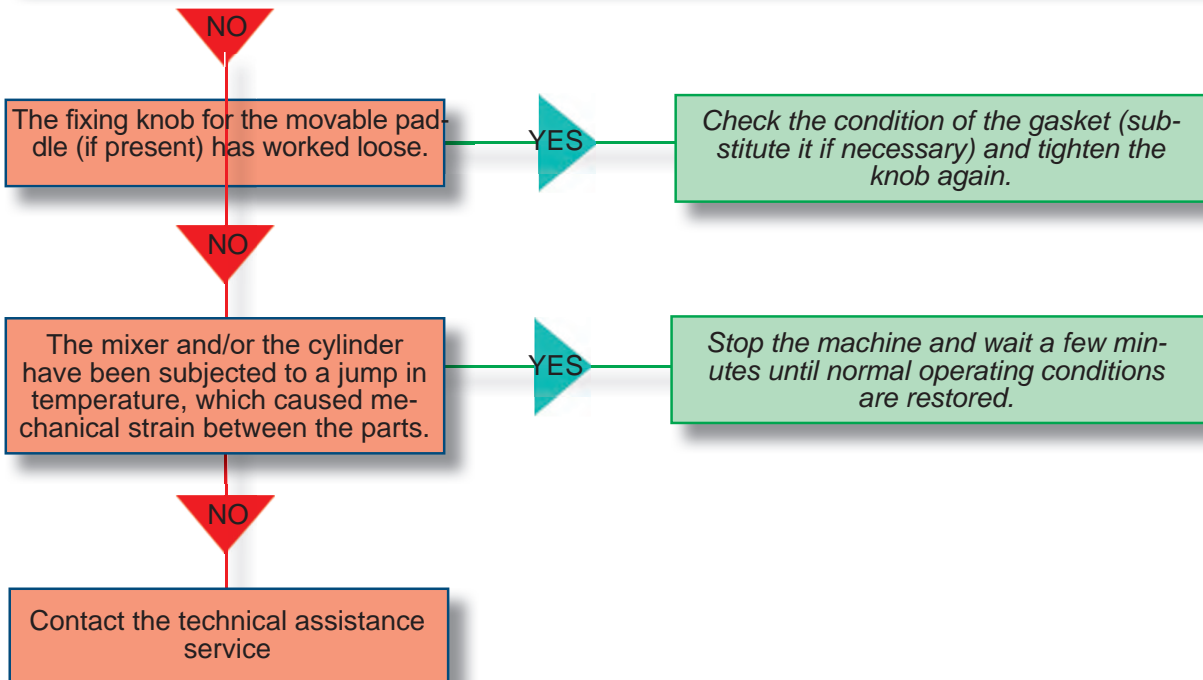

**COOLING IS INSUFFICIENT OR SWITCHES OFF IN A FAULTY WAY**  
**AIR-cooled machine**

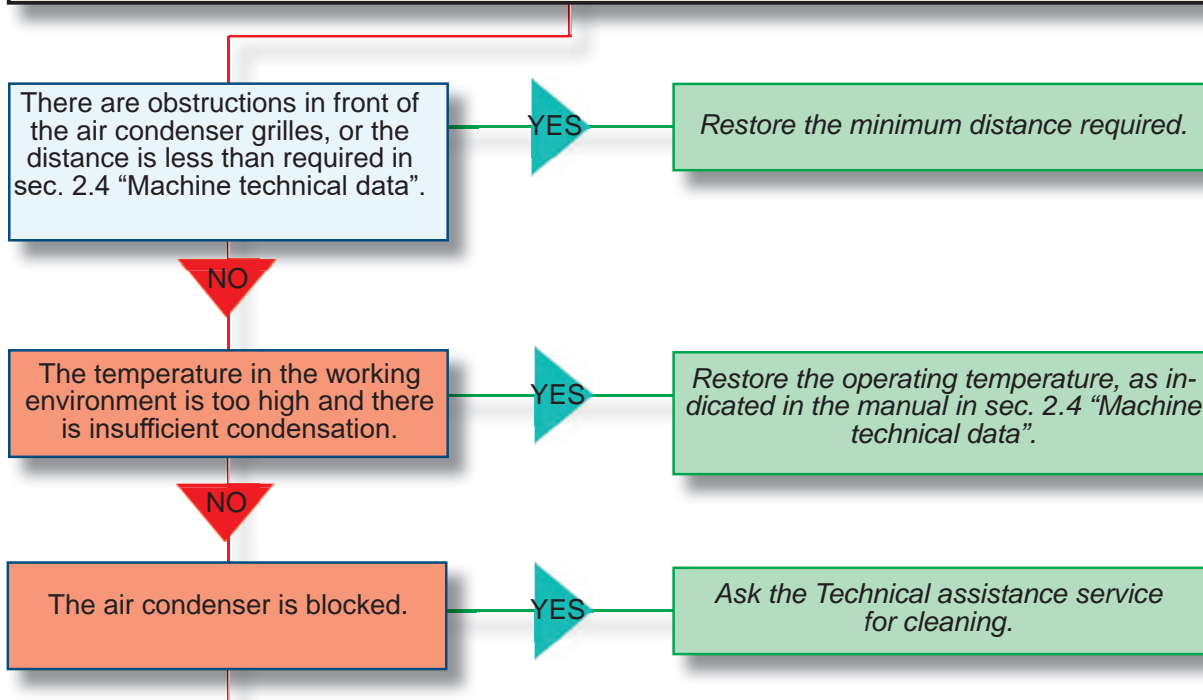



**COOLING IS INSUFFICIENT OR SWITCHES OFF IN A FAULTY WAY**  
**AIR-cooled machine**

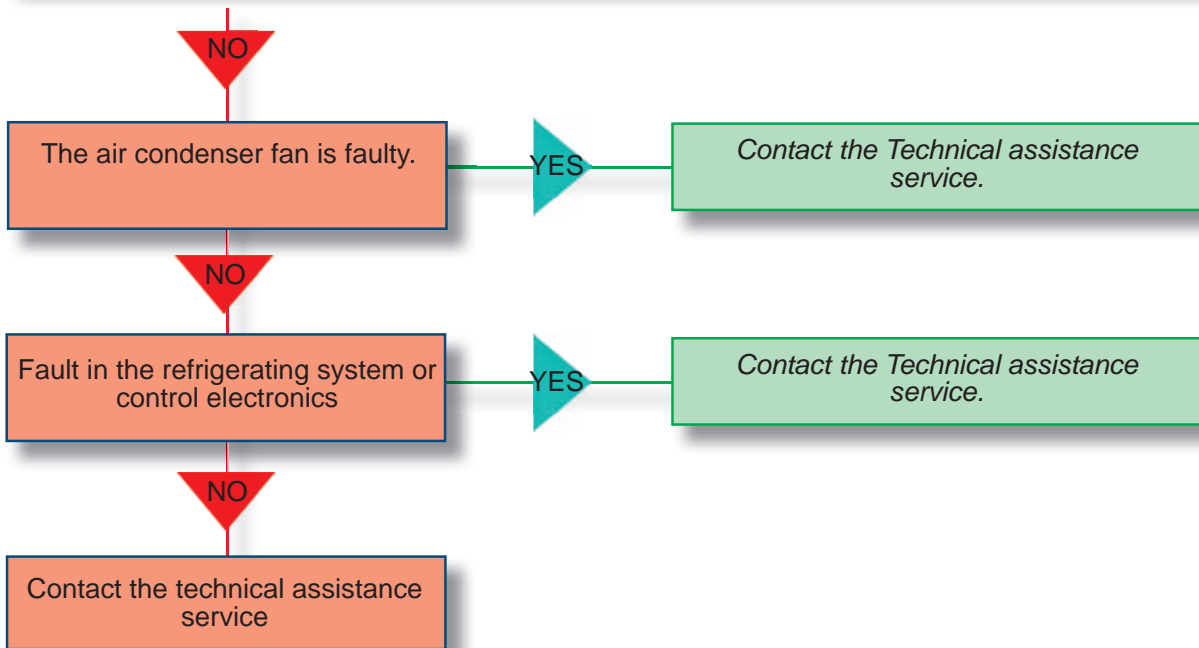

**COOLING IS INSUFFICIENT OR SWITCHES OFF IN A FAULTY WAY**  
**WATER-cooled machine**

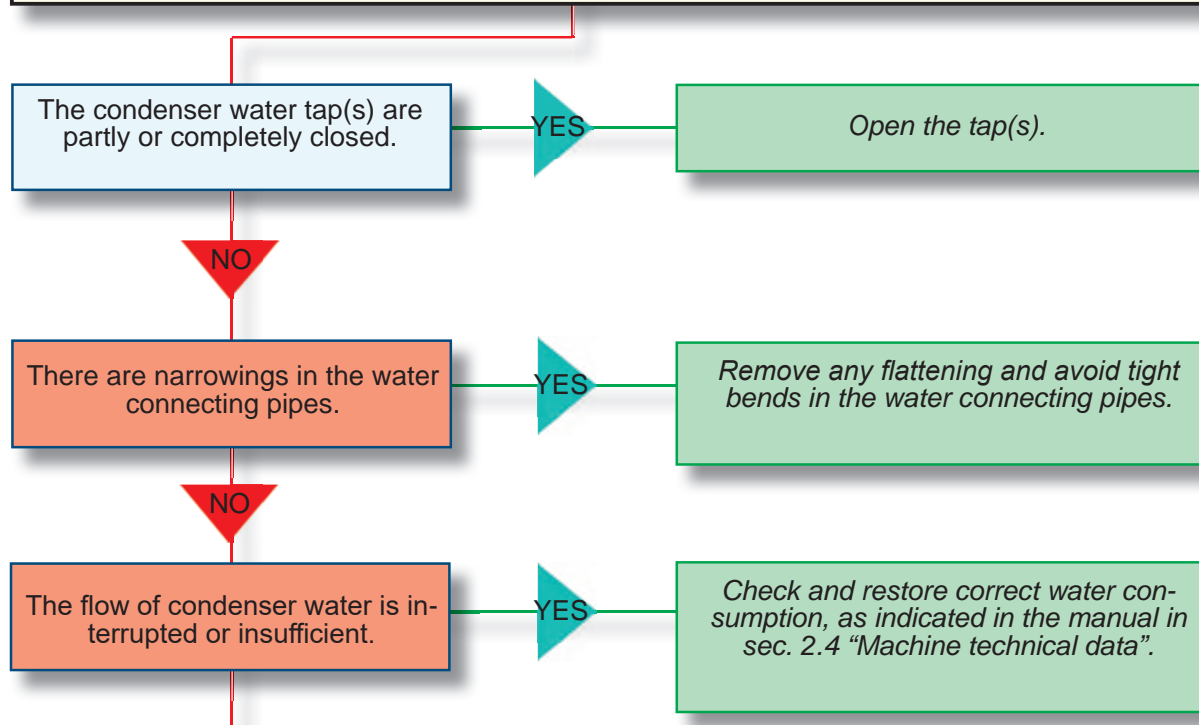

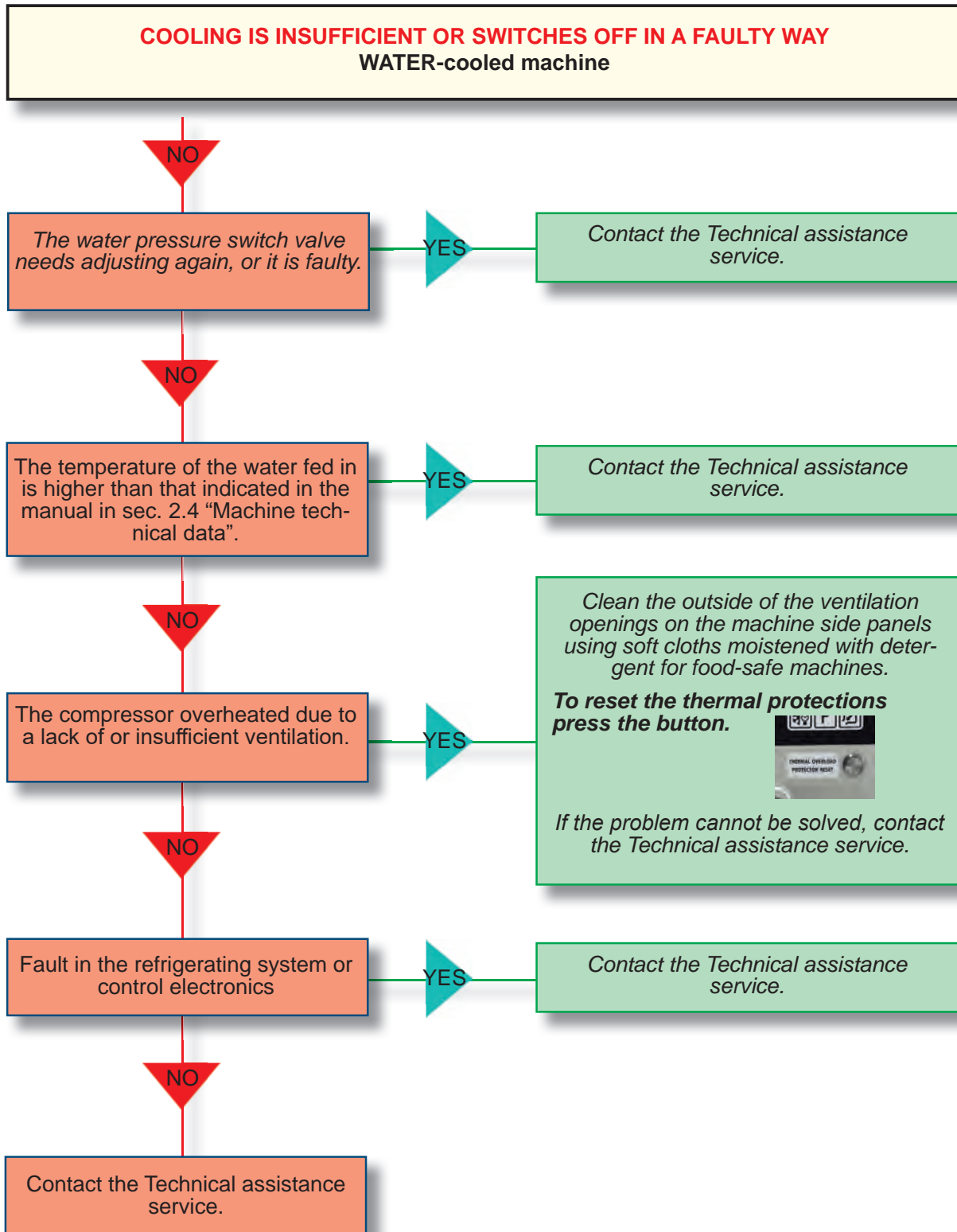



## 10 INACTIVITY

### 10.1 Keeping the machine efficient if it remains inactive

If the machine will not be used for a lengthy period, follow these instructions:

- Sanitise the machine as described in chapters 6/7.
- Switch off the machine using the I/O - ON/OFF button, power down at the mains master switch and take the plug out of the socket.

*If the machine that will be inactive has a water-cooled condenser, close the Water In tap and discharge the water pressure in the delivery tube by unscrewing the end connector. Remove both the delivery tube and the drainage tube and empty the water from them. Before using again after a long period of inactivity, check the connector gaskets for damage, substituting them if necessary.*



**BEFORE STORING A MACHINE THAT HAS A WATER-COOLED CONDENSER IN ENVIRONMENTS WITH TEMPERATURES BELOW 0°C, COMPLETELY EMPTY THE WATER FROM THE MACHINE COOLING SYSTEM, AS IT COULD FREEZE INSIDE IT, CAUSING VERY SERIOUS DAMAGE.**

*If a machine with an air-cooled condenser has been inactive, before switching it on remove dust from the condenser grilles “dry” with a vacuum cleaner and, if necessary, a brush, so that the dust is removed outwards.*



**DO NOT USE LIQUIDS BECAUSE THEY WOULD FIX THE DUST ON THE CONDENSER.**

**REMOVE DUST FROM THE CONDENSER GRILLES OUTWARDS TO AVOID COMPROMISING THE PERFORMANCE OF THE REFRIGERATING SYSTEM.**

---

## **11 DECOMMISSIONING THE MACHINE**

### **11.1 Description of method of disposal**

The lifetime of the machine estimated by the manufacturer is 20,000 hours (10 years) of operation under normal operating conditions, described in this operating manual. At the end of its lifetime the machine must be disposed of in accordance with the regulations in force in the country where it was used, concerning the disposal of waste electrical and electronic equipment.



**WHEN DISPOSING OF THE MACHINE ALWAYS COMPLY WITH THE REGULATIONS IN FORCE IN THE COUNTRY WHERE IT WAS USED.**



Notes: .....



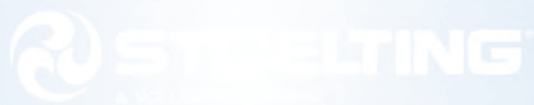

**TELME S.p.A.**  
Via S. Pertini, 10 - 26845 Codogno (LO)  
Tel.: +39.0377.466.650 - Fax: +39.0377.466.690  
e-mail: [telme@telme.it](mailto:telme@telme.it) - [www.telme.it](http://www.telme.it)

Edition 01-2021